

This manual is for reference and historical purposes, all rights reserved.

This page is copyright© by M. Butkus, NJ.

This page may not be sold or distributed without the expressed permission of the producer

I have no connection with any camera company

On-line camera manual library

This is the full text and images from the manual. This may take 3 full minutes for the PDF file to download.

If you find this manual useful, how about a donation of \$3 to: M. Butkus, 29 Lake Ave., High Bridge, NJ 08829-1701 and send your e-mail address so I can thank you. Most other places would charge you \$7.50 for a electronic copy or \$18.00 for a hard to read Xerox copy.

This will allow me to continue to buy new manuals and pay their shipping costs.

It'll make you feel better, won't it?

**If you use Pay Pal or wish to use your credit card,
click on the secure site on my main page.**

PayPal Name Lynn@butkus.org



PROMINENT II

24 x 36 · 35 mm

Instructions for use

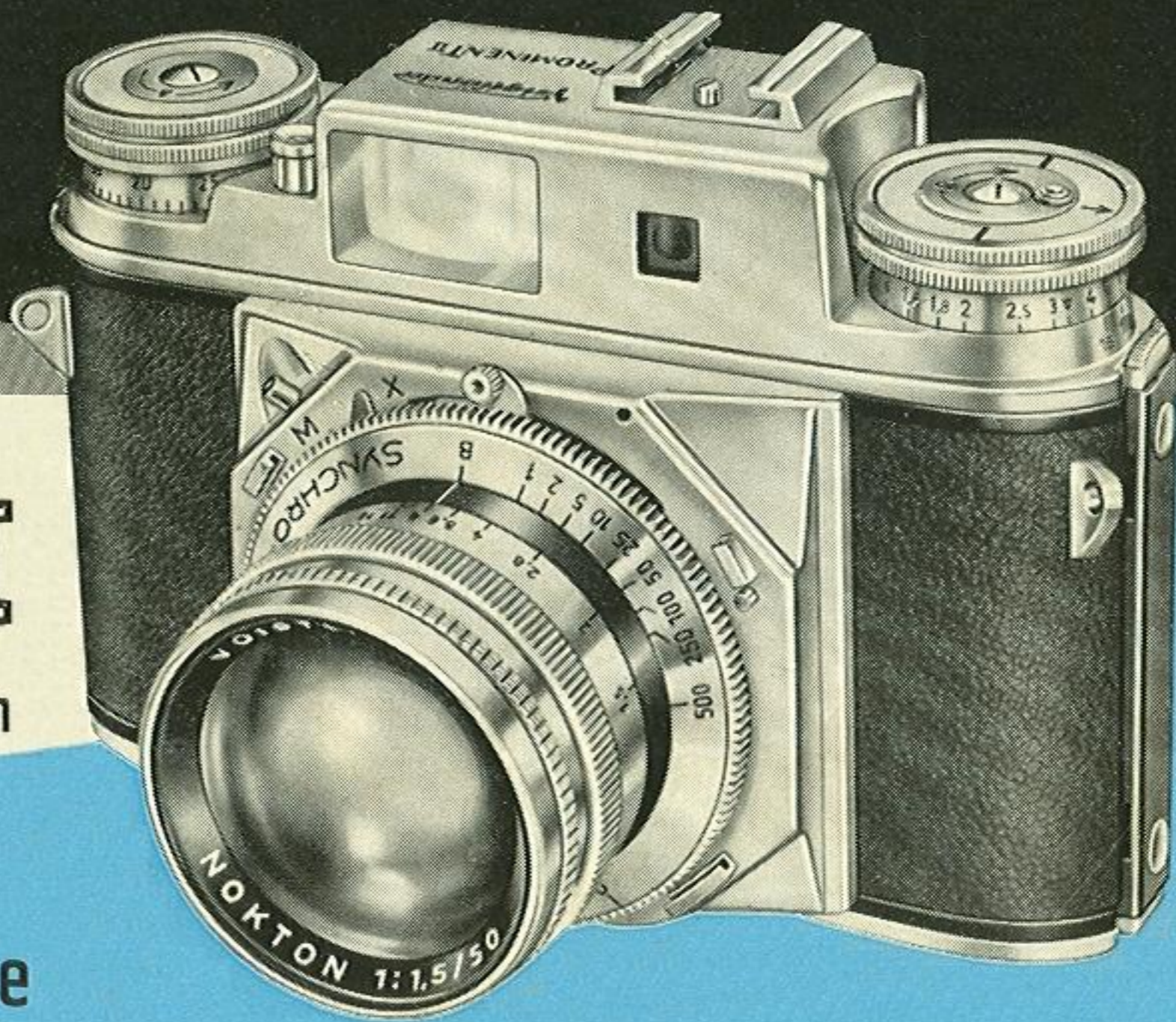



The most important point of the whole booklet of instructions is on this page: You are requested to read the instructions carefully, and to make yourself familiar with the manipulation of your camera before you start taking photographs.

You should always bear in mind that the PROMINENT is a mechanical precision instrument which must be handled with feeling and understanding. It will repay your care with an endless number of beautiful and wonderfully sharp pictures.

VOIGTLÄNDER A.G. BRAUNSCHWEIG

	Page
<i>Contents</i>	
Inserting the film	6–10
Unloading the camera	11
Changing partly exposed films	11
Changing lenses $f = 50$ mm	12
Shutter · Aperture · Brilliant-frame view and rangefinder	13–16
Snapshot focusing	17
Holding the camera	18
Synchronised flash shots	19–21
Focar lenses · Proximeter	22–23
Repro · Macro · Micro	24–26
Turnit-3-viewfinder	27
Filters	28
Shots against the light	29
Aperture and depth of field	30
Care of camera and lenses	31

PROMINENT II

24 x 36 · 35 mm

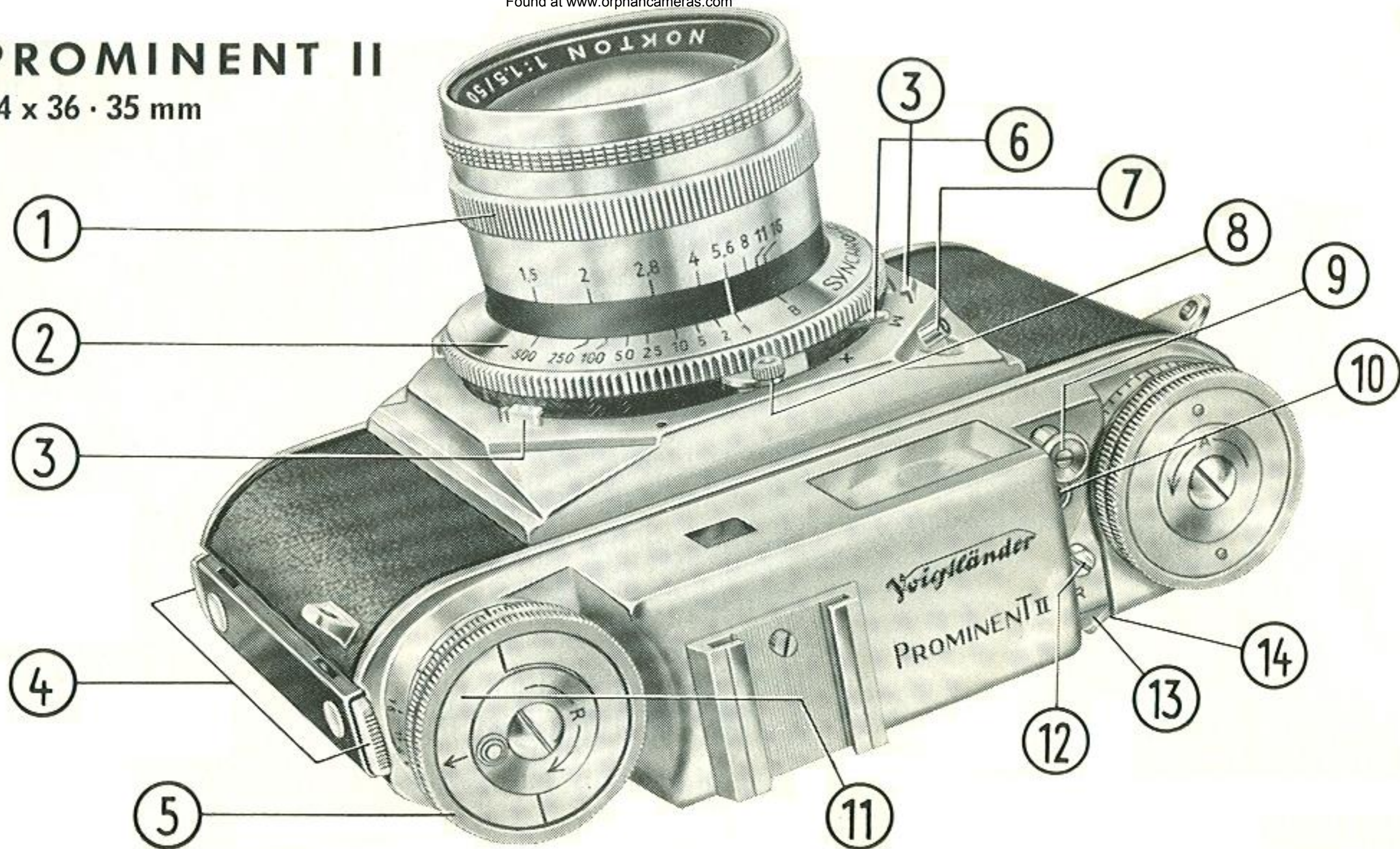

2

- | | | |
|--|---|--|
| <p>1 Aperture ring
to set the iris diaphragm</p> <p>2 Shutter speed ring
to set the shutter speeds</p> <p>3 Jaws
to hold the interchangeable lenses</p> <p>4 Latch
to close the back</p> | <p>5 Focusing knob of the rangefinder</p> <p>6 Synchronizing lever
to set the MX synchronisation</p> <p>7 Flash socket
to connect the flash gun</p> <p>8 Shutter lever
to tension the selftimer</p> <p>9 Shutter release</p> | <p>10 Threaded cable release socket</p> <p>11 Rewind key</p> <p>12 Rewind button
to enable rewinding</p> <p>13 Rapid lever wind</p> <p>14 Film release
(covered by the rapid winding lever)</p> |
|--|---|--|

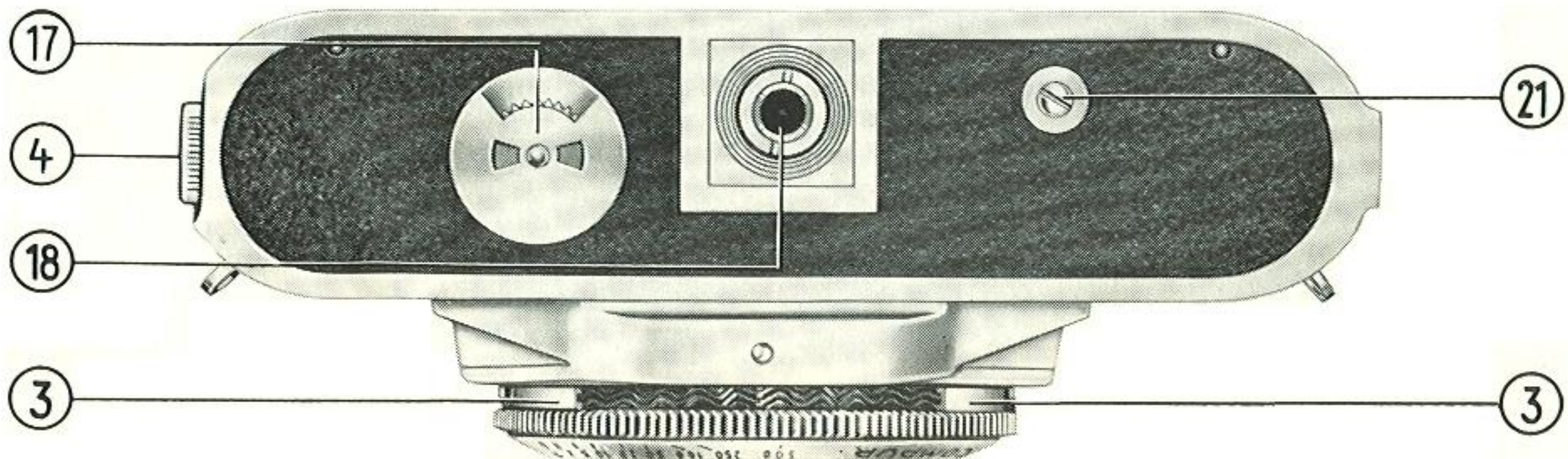
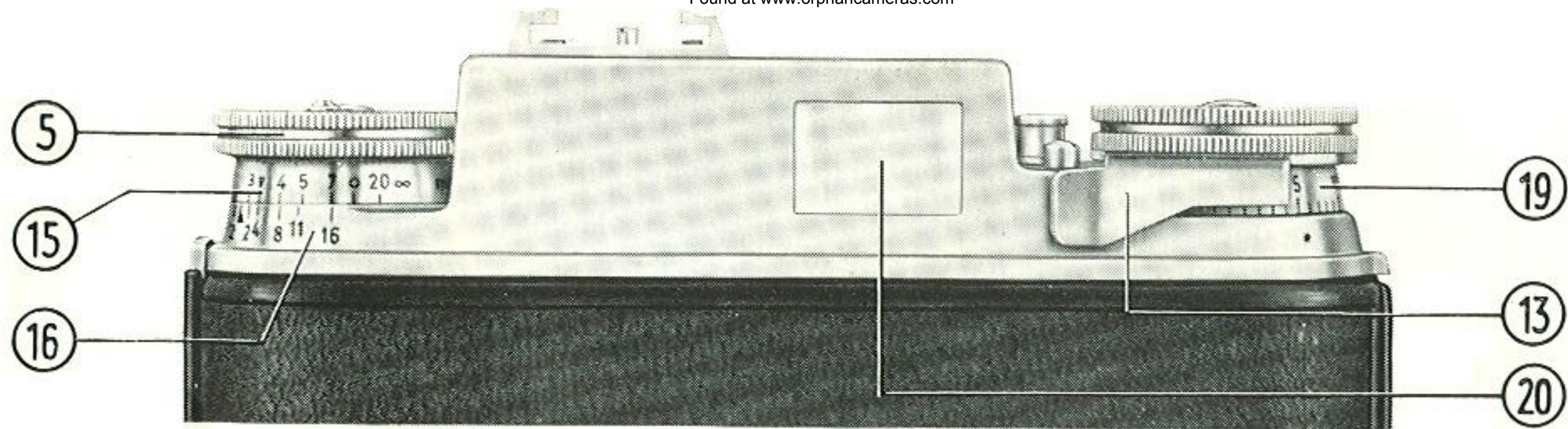

- 3 Jaws to hold the interchangeable lenses
- 4 Latch to close the back
- 5 Focusing knob of the rangefinder
- 13 Rapid lever wind

- 15 Distance scale
- 16 Depth of field indicator
- 17 Film indicator
- 18 Tripod bush

- 19 Film counter
- 20 View- and rangefinder eye-piece
- 21 Rewinding indicator

Loading the camera

The PROMINENT II requires no special film. Standard 35 mm. miniature film for 24 x 36 mm. negatives is commercially available as black-and-white as well as colour film in daylight cassettes of 36 or 20 exposures.

Although the cassettes are light-tight, it is advisable not to expose them to strong light. Make a point therefore of always loading and unloading the camera in the shade – even the shadow of your own body will do.



Opening the Back

Press together both latches on the left side of the camera and pull the back away from the body.

- 11 **Rewind key**
to rewind the film. Showing the handle open and the key pulled out.
- 12 **Rewind button**
to enable rewinding
- 13 **Rapid lever wind**
- 19 **Film counter**
- 22 **Film chamber**
- 23 **Film guides**
- 24 **Film transport shaft**
with two sprocket wheels which must engage the perforations on both sides of the film.
- 25 **Take-up spool**

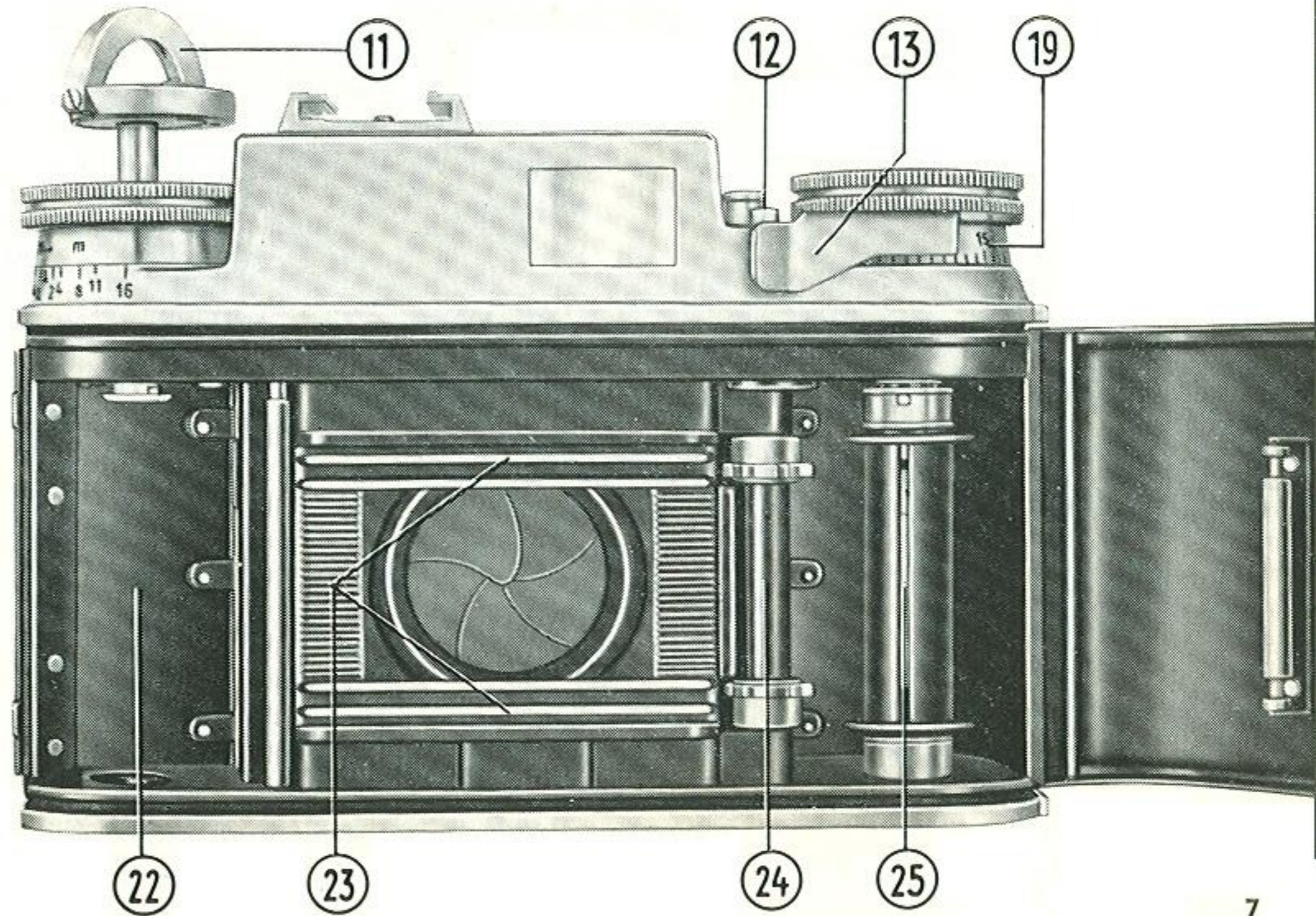



The Rewind Key

Pull up the semi-circular handle as far as it will go. On pushing the button on top of the key the spring-loaded handle opens automatically.

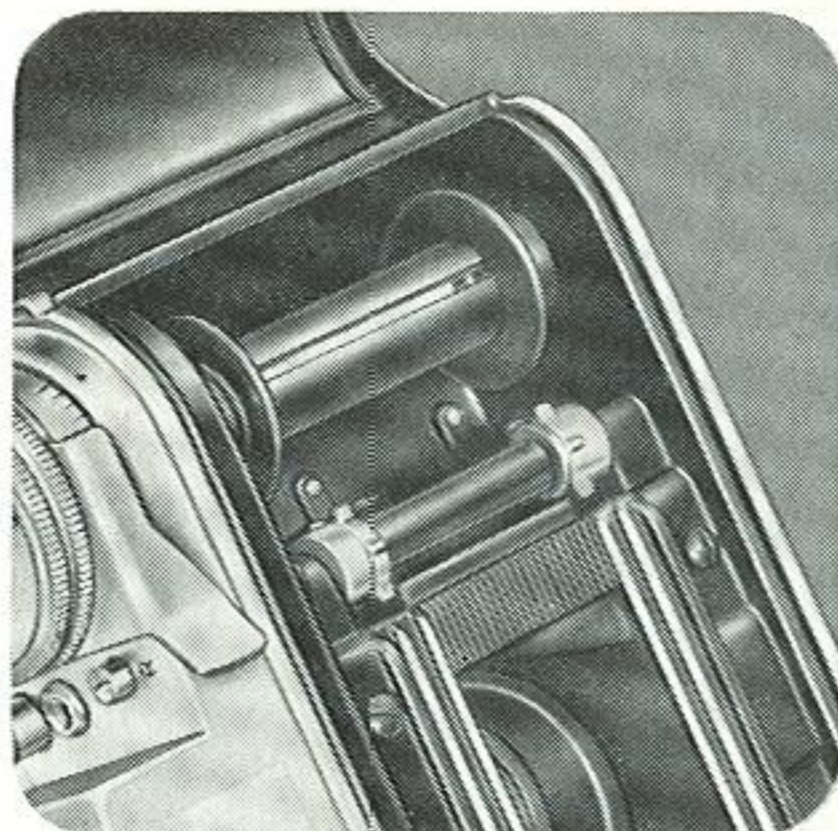

Turn the Take-Up Spool

by means of the rapid lever wind until the longer of the two slots points upwards (see middle illustration). If the rapid lever wind should become locked too early, press the film release once.

Fold down approx. $\frac{5}{16}$ in. of the film leader and push it into the slit of the take-up spool until it wedges between the core and the shell of the spool, pointing towards the centre of the camera (right).

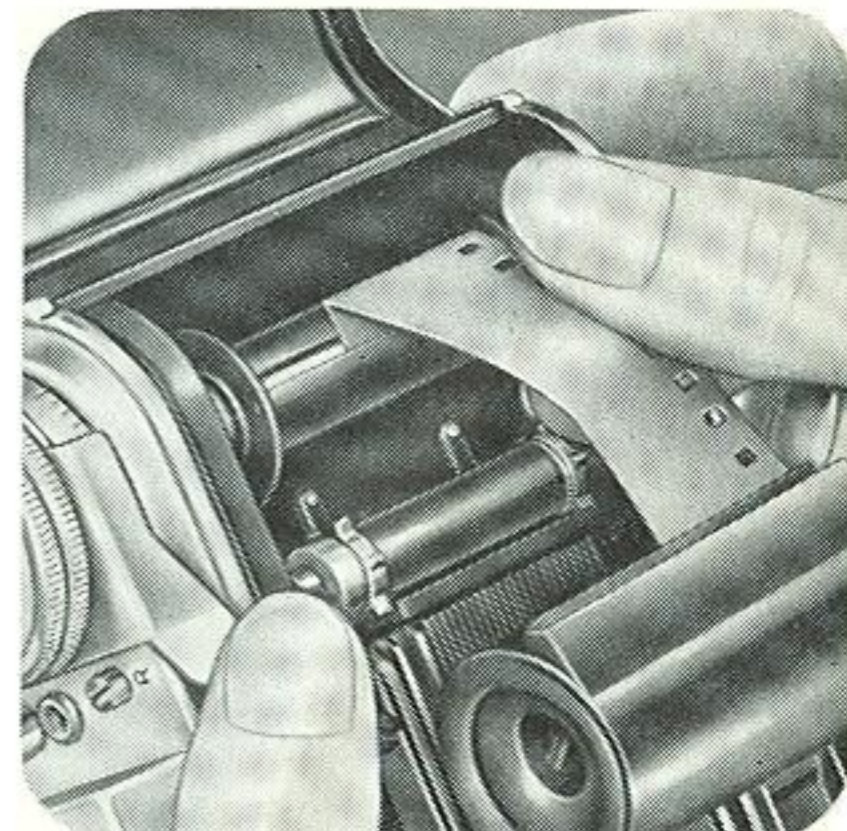

Pull the Cartridge

over the film guides and insert it in the film chamber. Push back the rewind key, giving it a slight twist if necessary, and fold down the handle.

Close the Back

The illustration on the right demonstrates how the loaded camera must look like before it can be closed. Make sure that both latches engage properly.

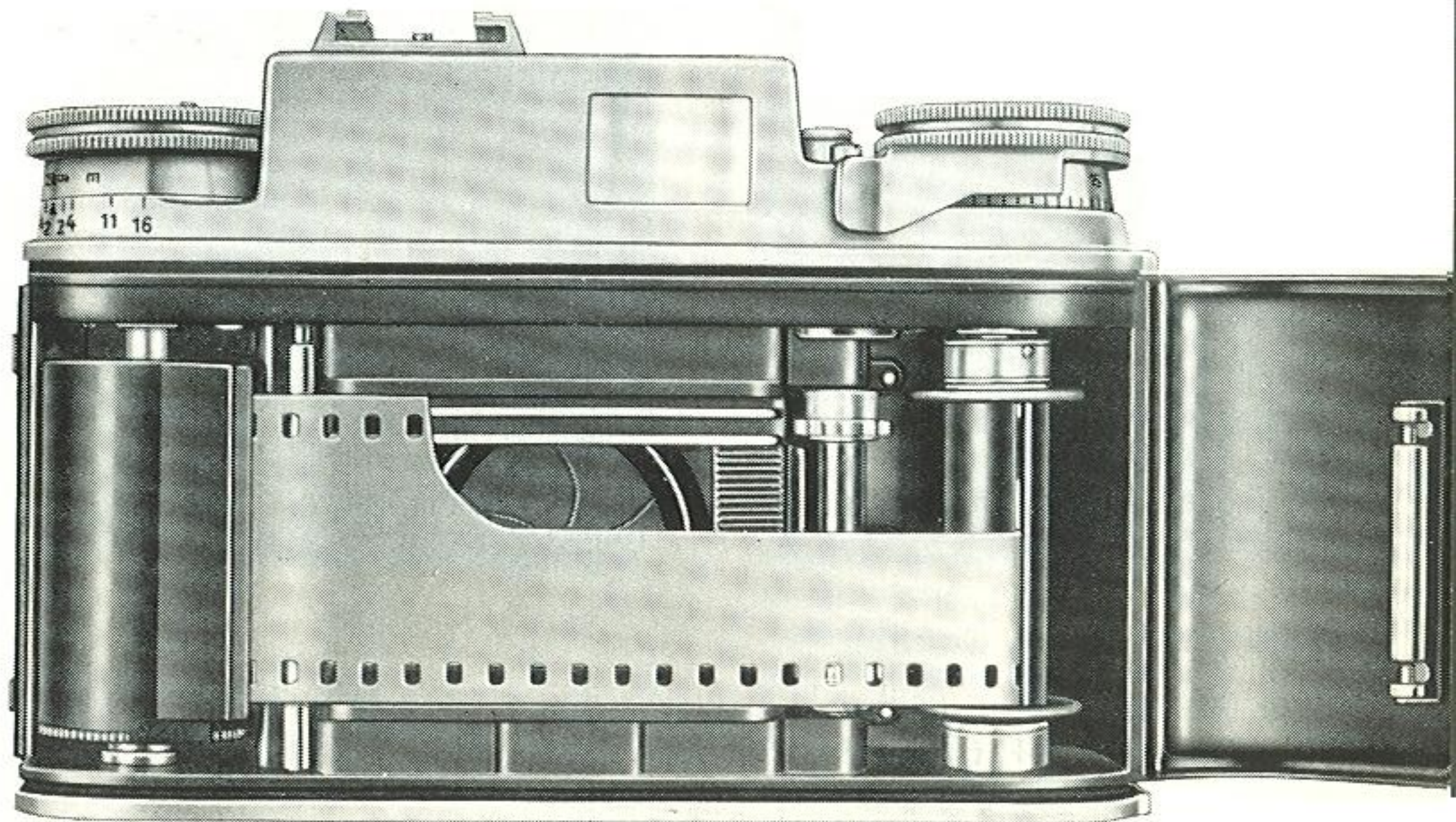

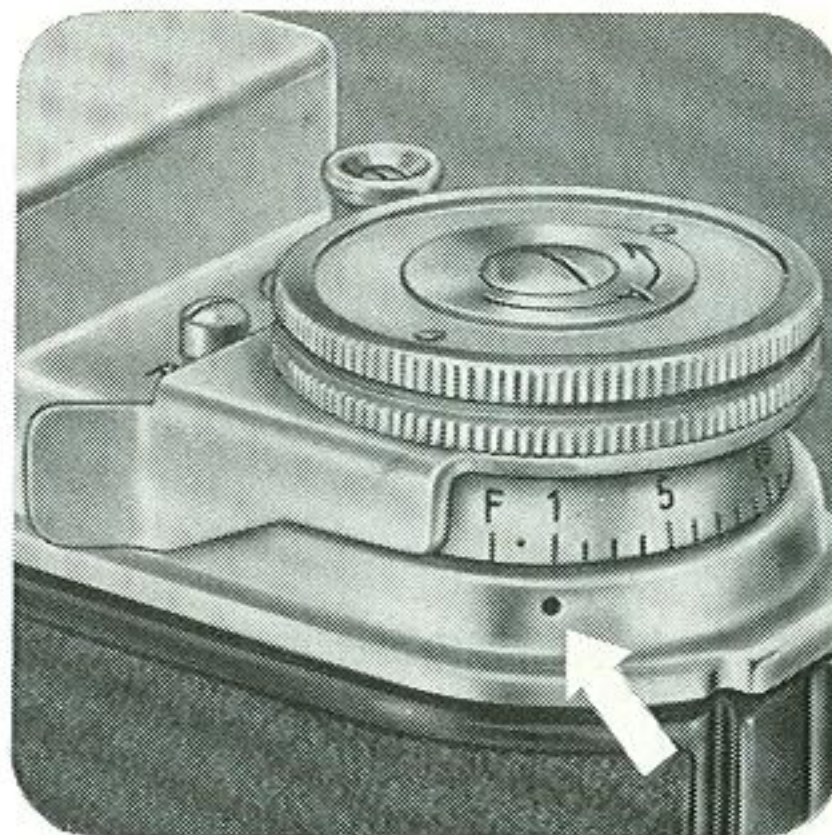
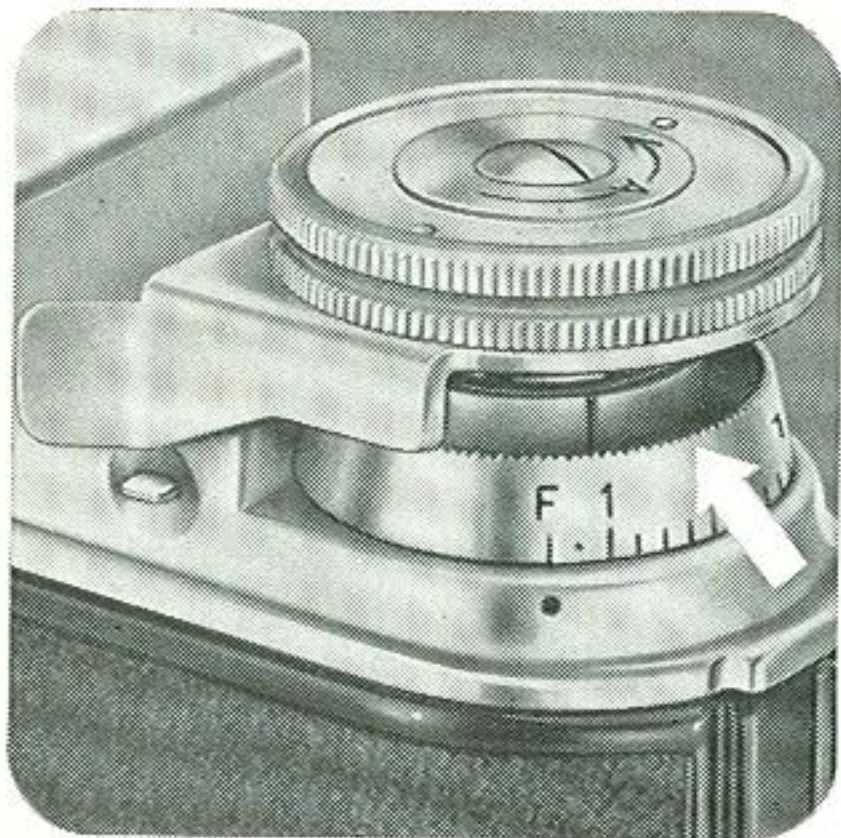

Setting the Film Counter

Turn the rapid winder until it locks (unless it is already locked). Then pull it up and turn the counting disc to set the letter F exactly opposite the index mark (see arrow in left illustration).

Push the rapid winder back again until it fits tight on top of the counting disc. Press the film release once and turn the rapid winder until it locks. Repeat this once more. Now the index mark points to No. 1 (see illustration on the right) and the film is in position for the first exposure.

After Loading

set the film indicator on the base plate of the camera. Choose your own colour code for the different films to help your memory.

Please note: The film release (15) underneath the lever of the rapid winder (see illustration on the left) is used in practice only for loading and changing partly exposed films (see page 21). Do **not** use it for rewinding.

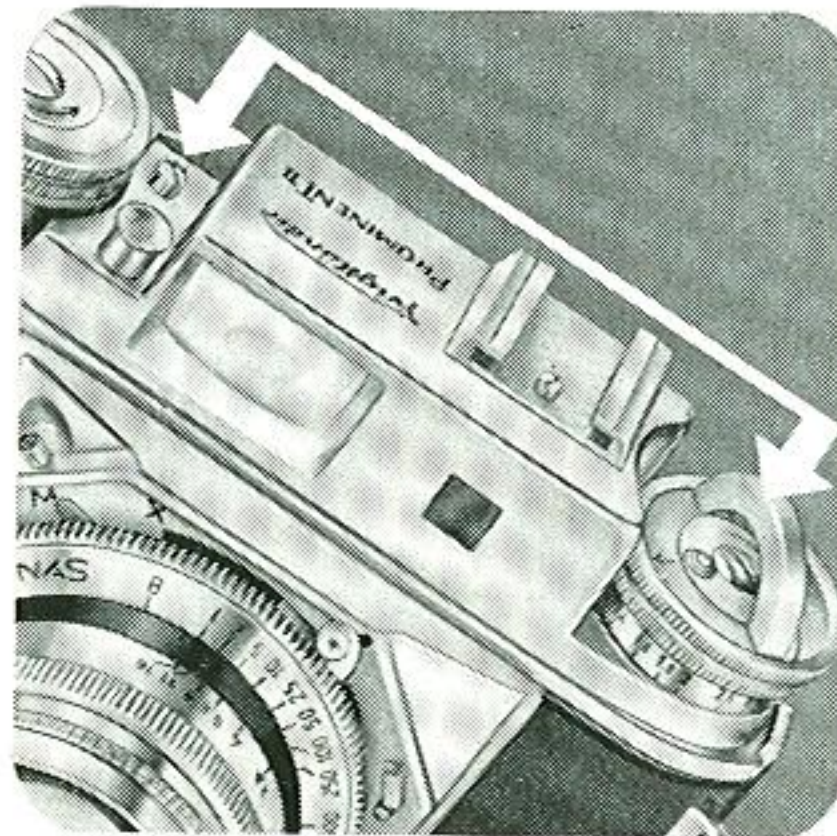
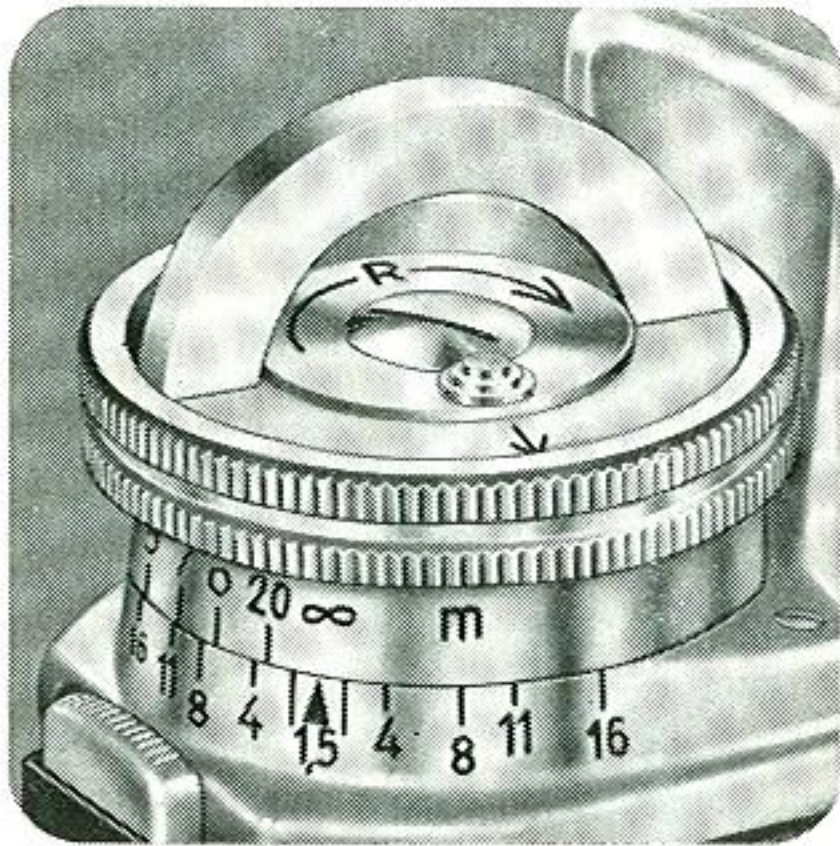

Unloading the Camera

After the last exposure lift up the handle of the rewind key, but do **not** pull out the rewind key itself (left). Depress the rewind button and keep it depressed while turning the rewind key in the direction of the engraved arrow (right).

While rewinding the film, watch the slotted end of the film transport shaft turning in the base of the camera (see ill. p. 5). When it ceases to turn release the rewind button, and pull out the rewind key by its handle. Finally open the camera back and take out the cartridge.

Partly Exposed Films

are easily changed at any time (e. g. black-and-white against colour). Rewind the partly exposed film as described, but make a note of the last number on the film counter.

When reloading a partly exposed film, proceed in the usual way up to setting the film counter to No. 1. Then lift rapid winder with milled knob **half way**, slightly turn same, and the film release (15) will become accessible. Depress rapid winder and press the film release. Keep it pressed down with your left thumb while turning the rapid lever in short movements until the film counter indicates once more the previously noted number.

Let go film release and turn lever until it becomes locked. Then finish exposing the film in the normal way.

The optical outfit

With the interchangeable lenses

Ultron	2,0/50 mm
Nokton	1,5/50 mm
Skoparon	3,5/35 mm
Dynaron	4,5/100 mm
Super-Dynaron	4,5/150 mm

a series of Voigtländer high efficiency anastigmats is available offering all possibilities to adapt yourself to the prevailing photographic situation.

Note: The instructions for changing lenses and the sections on focusing, depth of field etc., apply only to the standard 50 mm lenses. A special instruction booklet is supplied with all lenses having a different focal length.

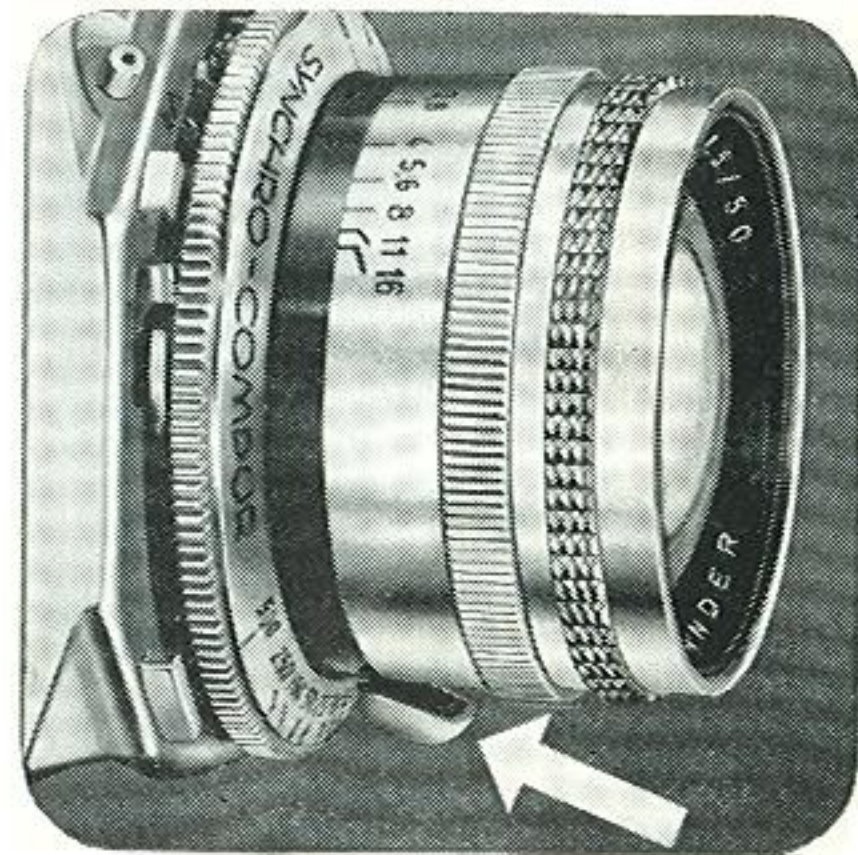

Changing the 50 mm Lenses

When inserting the lens push it into the shutter (left) and turn it until you hear the inner bayonet engage with a click. When the lens is in the correct position, the catch must be underneath.

To remove the lens, pull the catch forward (right), turn the lens about 60° to the left or right, and lift it out. **ALWAYS CHANGE LENSES CAREFULLY AND NEVER USE FORCE.**

The Synchro-Compur diaphragm shutter

has speeds from 1 – $\frac{1}{500}$ second as well as a delayed action mechanism (selftimer) and is speed-synchronised for all types of flash (MX). The correct contact can be set with the synchronizing lever (see flash pictures, pages 19 to 21). For all photos without flash it is immaterial whether the synchronizing lever is set to M or X. A double set of shutter blades renders it absolutely light proof.

Tensioning the shutter – as well as film transport and advancing the film counter at the same time – will be effected with the rapid winding lever (see illustration top right). This must be pulled to the right so often (normally twice) until it becomes locked.

The automatic interlock prevents double exposures and blanc frames. Thus you cannot tension the shutter unless there has previously been an exposure, nor will you be able to press the shutter release unless the rapid winding lever has been fully advanced.



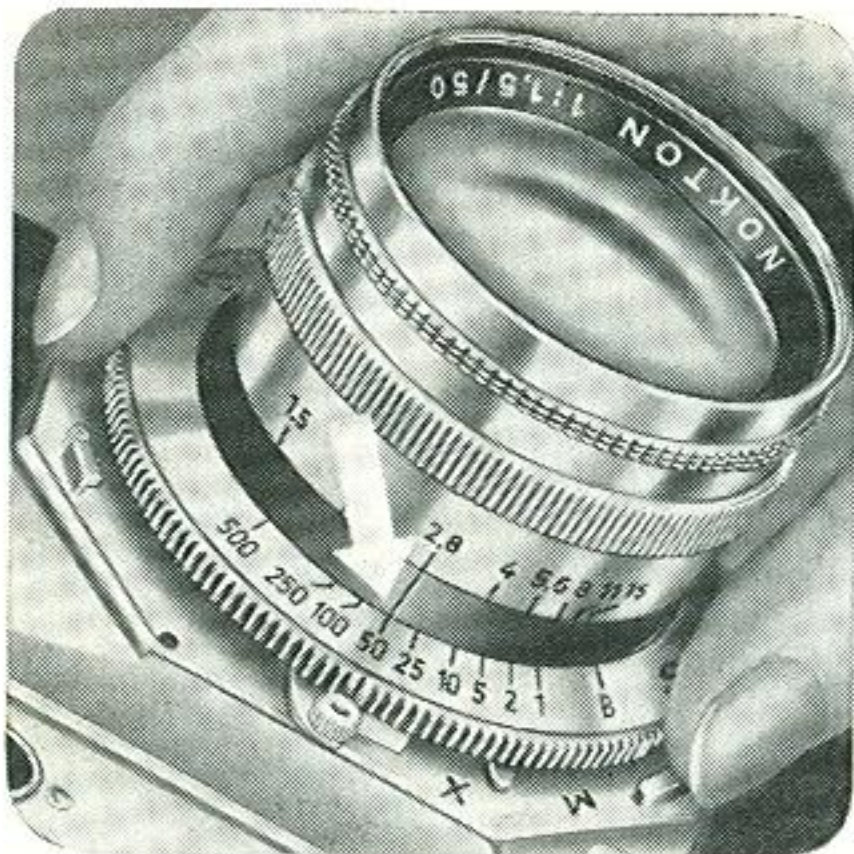

Setting the Shutter Speeds

Turn the shutter speed ring until the selected speed is opposite the index line on the lens mount. The shutter can be set to any intermediate speeds, except between $1/10$ and $1/25$ second, or between $1/250$ and $1/500$ second. All speeds other than $1/500$ second can be set after tensioning the shutter.

For time exposures over 1 second, set the shutter to B. Press the release, and the shutter will stay open as long as the release is pressed down. For time exposures, it is advisable to use a cable release, preferably with locking device. The cable screws into the threaded socket behind the shutter release (centre).

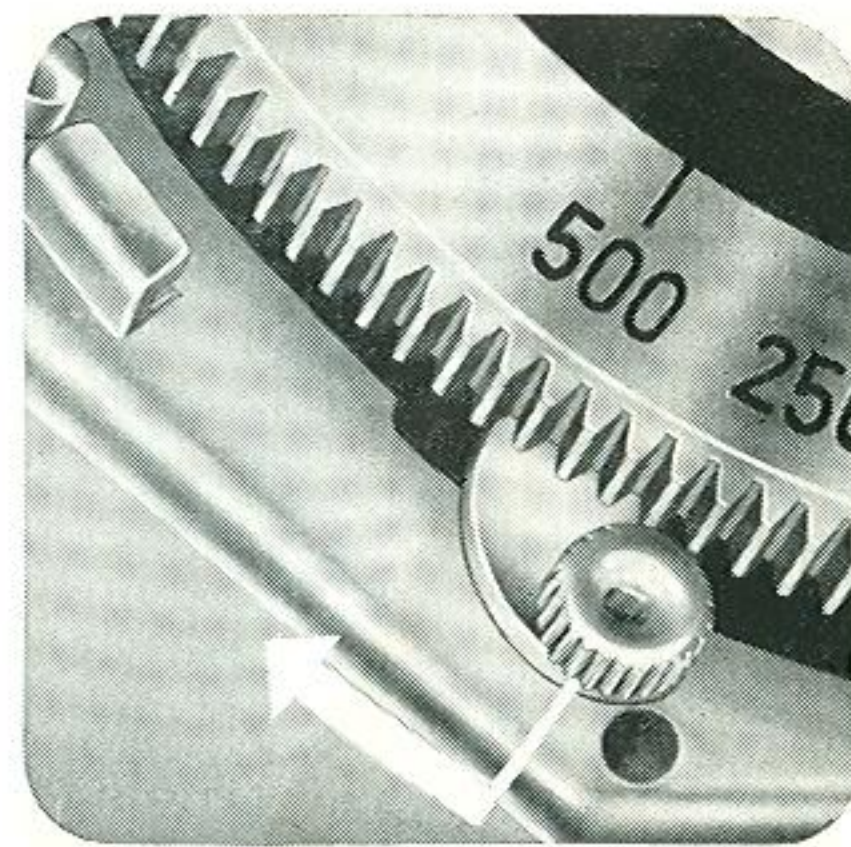
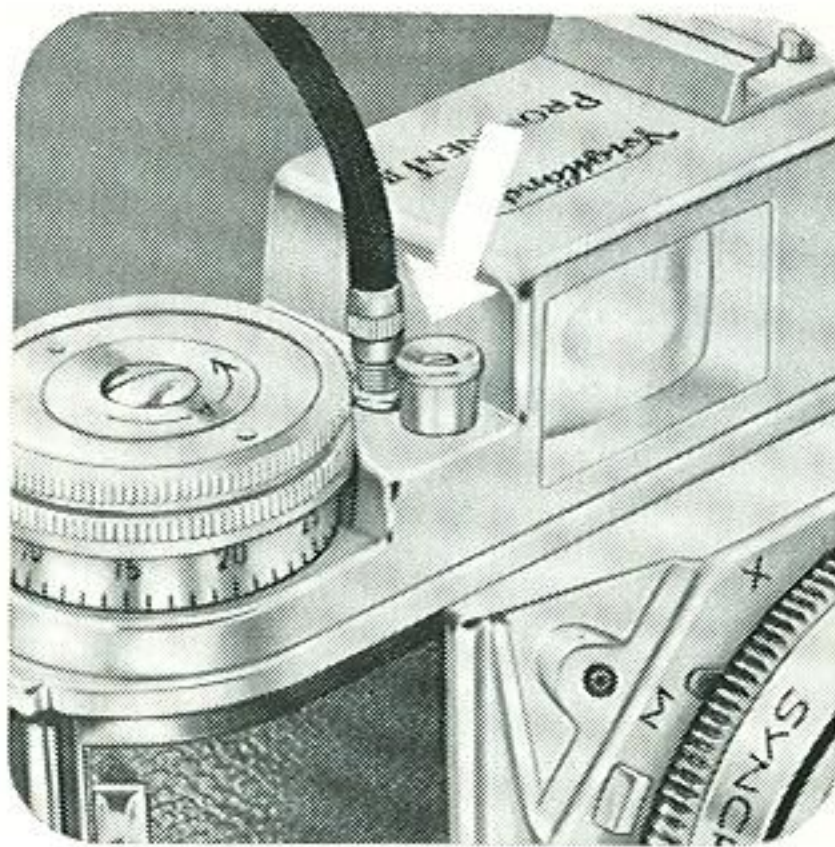

The Self-Timer

When the shutter is tensioned, the tensioning lever is next to the red dot. Pulling it further till as far as it will go, automatically brings a delay mechanism into action, which opens the shutter about 10 seconds after release.

Note: Do not use the self-timer with the shutter set to B or to $1/500$ second.

Aperture and shutter speeds

The aperture (or stop) of the iris diaphragm controls the amount of light falling on the film and thus the exposure. It also controls the depth of field. Page 33 tells you how to determine the depth of field.

Note that the largest aperture (f/1.5 with the NOKTON and f/2 with the ULTRON) allows the greatest amount of light to pass through the lens. The successive numbers of the aperture ring halve the amount of light from number to number.

This means in practice that in identical lighting conditions you must halve or double the shutter speed from stop to stop either way. You may also set intermediate values, described under "Setting the Shutter Speed".



Setting the Aperture

Turn the aperture ring until the selected stop is opposite the white index line. The whole of the scale is clearly visible at a glance from above.

The view and rangefinder

are combined in a brilliant-frame view- and rangefinder 1 : 1 showing the subject in full natural size. Superimposed brilliant image frames outline the limit of field of views for the focal distances 1 $\frac{3}{8}$ in. (35 mm), 2 in. (50 mm), 4 in. (100 mm), and 6 in. (150 mm).

Viewing the Subject: On looking through the viewfinder ocular you bring your subject into the correct superimposed frame (see ill. below). With close-ups at 3 $\frac{1}{2}$ feet (1 meter) with the 35, 50 and 100 mm lenses the field of view is displaced downwards or sideways as indicated by the two short lines on the respective image frames, according to which way the camera is held.

Focusing: In the centre of the brilliant-frame finder you can see the bright circular rangefinder field. As long as the rangefinder is not correctly focused on the subject, the latter appears with double outlines in the rangefinder field (see top ill.).

Turn the focusing knob (5) to fuse the double outlines in the rangefinder field into one whereby lenses of 35, 50 and 100 mm focal distance are focused automatically. For $f = 150$ mm focal distance you read the distance on the scale under the focusing knob and set the distance on the scale on the lens mount correspondingly.

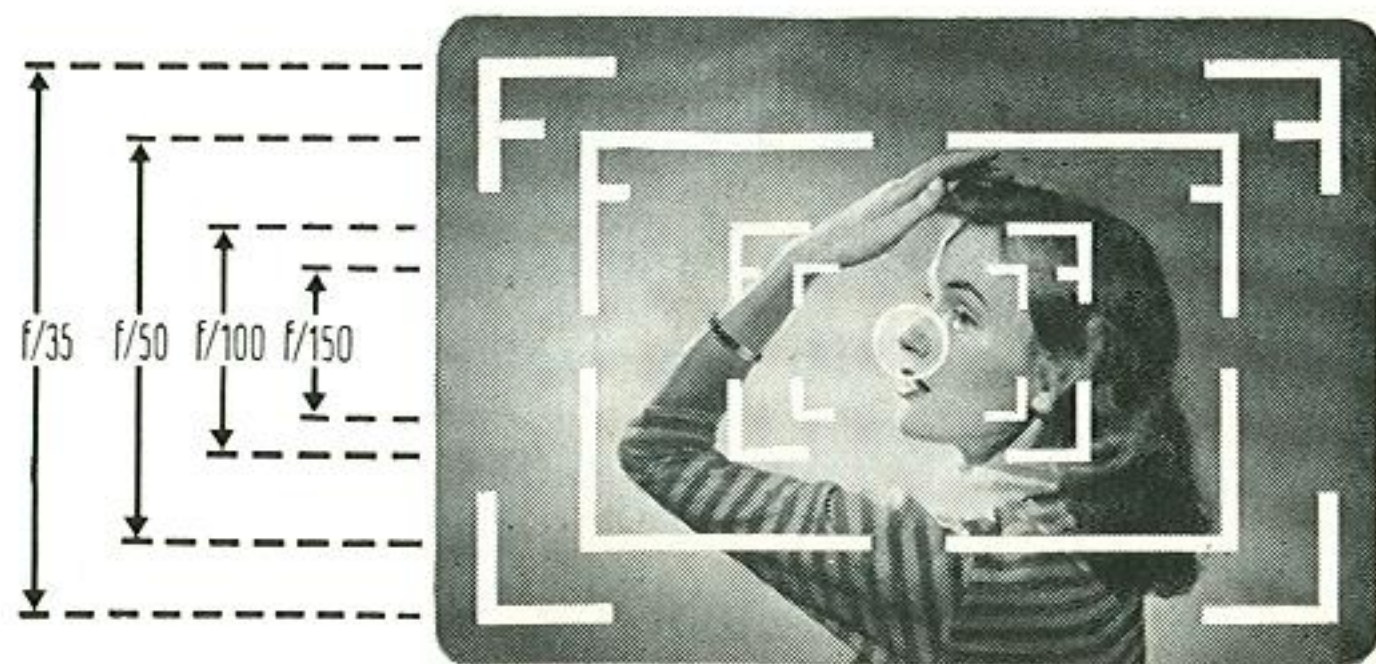
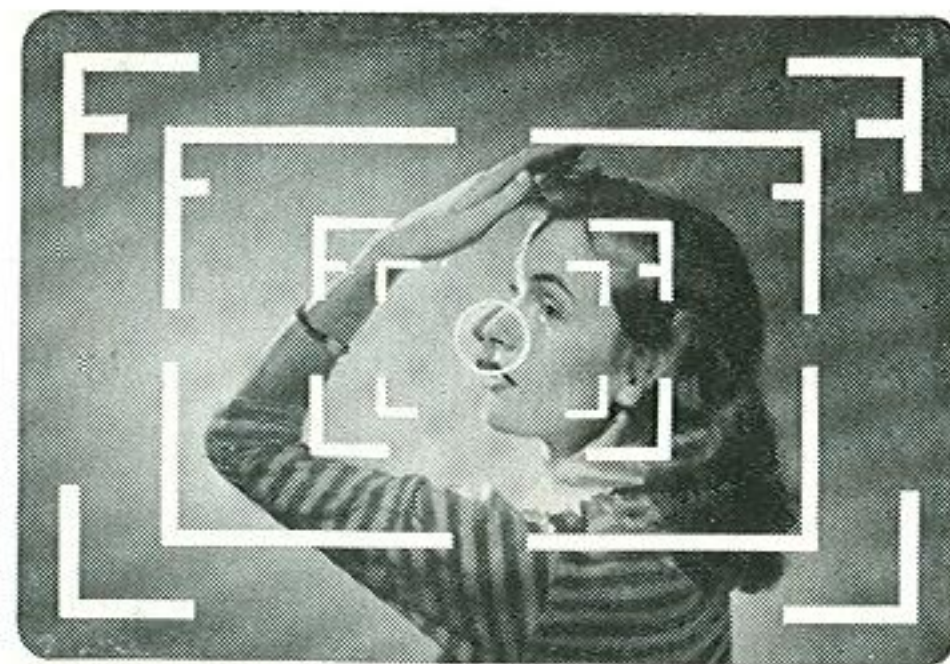

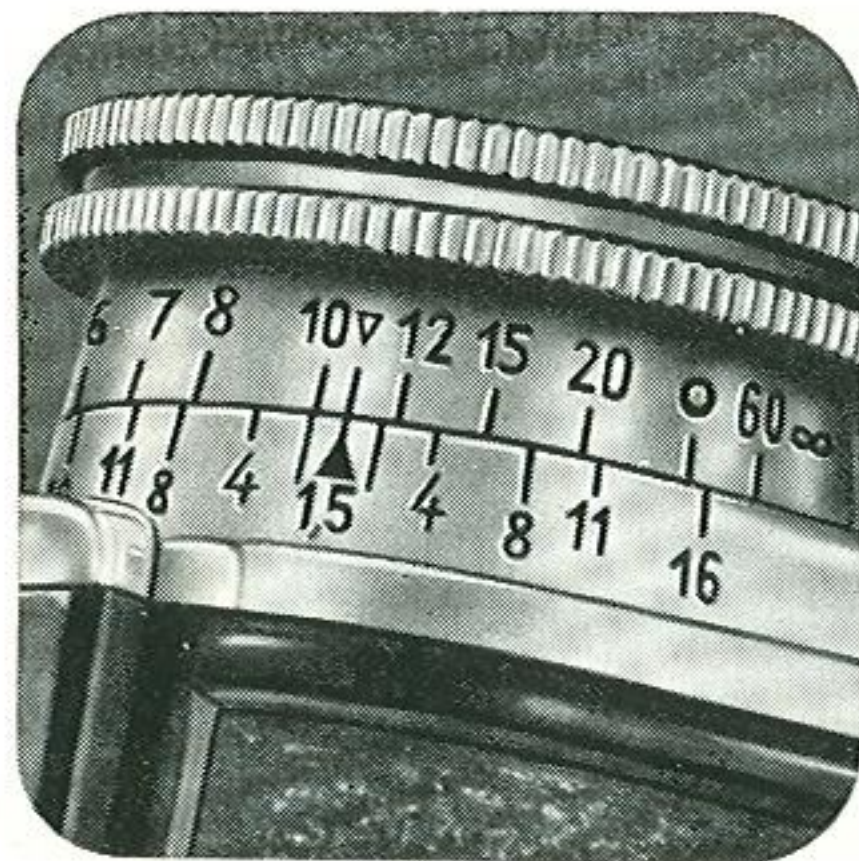

Snapshots

Candid action shots (e. g. sports, street-scenes, children at play) often yield surprisingly live pictures. On such occasions don't waste time by setting the exact distance with the rangefinder but use the snapshot marks ∇ and \circ on the distance scale on the focusing knob.

At f/8 the ∇ mark setting (11 feet) gives you a sharp depth of field from 8 to 16 feet (see top ill.) at f/8 setting the distance at \circ extends from 16 feet to infinity (see top ill.).



Holding the Camera

It is advisable to hold the camera as shown in the illustrations. Slightly press the top of the camera against your forehead to keep it steady, and to avoid camera shake during exposure.

Hold your breath during exposure and press the release down gently as far as it will go. Don't jerk it.

Slow Speeds

To shoot with the camera held in the hand at speeds slower than $\frac{1}{25}$ second, e. g. $\frac{1}{10}$, $\frac{1}{5}$, $\frac{1}{2}$, and even 1 second, you need a very steady hand, or some support for your arms and body.

A useful trick to reduce the risk of camera shake with shots of static subjects, e. g. interiors, is to use the self-timer which normally serves for taking pictures of yourself.

Tension the shutter in the usual way, set the shutter speed, and start the self-timer. After about 10 seconds, the shutter will release itself without any shake. But do not move the camera until you have heard the shutter close with an audible click.

Flash shots

The Synchro-Compur shutter permits speed-synchronized flash shots up to the fastest shutter speed of $1/500$ second. Any flash gun on the market can be connected to the shutter.

Mounting the Flash Gun on the Camera

Small light-weight units such as the Voigtländer battery-capacitor flash gun can be fitted directly into the accessory shoe of the camera (see illustration). Larger flash guns or the reflectors of electronic flash units are generally fitted to the side of the camera by means of a special bracket.

The flash cable completes the electric circuit between the flash unit and the camera shutter. Push the plug of the flash cable into the flash socket (7).



Setting Synchronisation and Aperture

Since the shutter must be fully open at the moment when the flash reaches its peak brightness, the synchronisation (M or X) must be set to suit the type of flash in use.

- Flash bulbs and electronic flash tubes differ in the time they take to reach their peak. They thus fall into several classes as shown in the table opposite. Set the synchronising lever either to X or M, according to the flash used (see ill.). Then set the shutter speeds according to the values shown in the table. Tension the shutter in the usual way. **Note:** When using the self-timer, only the shutter speeds indicated under X can be used.
- On the packing of flashbulbs, or in instructions enclosed with the bulbs or electronic unit you will find details about "guide numbers" which govern the aperture setting. Dividing the guide number by the distance (in feet) from flash to subject gives you the aperture setting (**aperture = guide number: distance**).

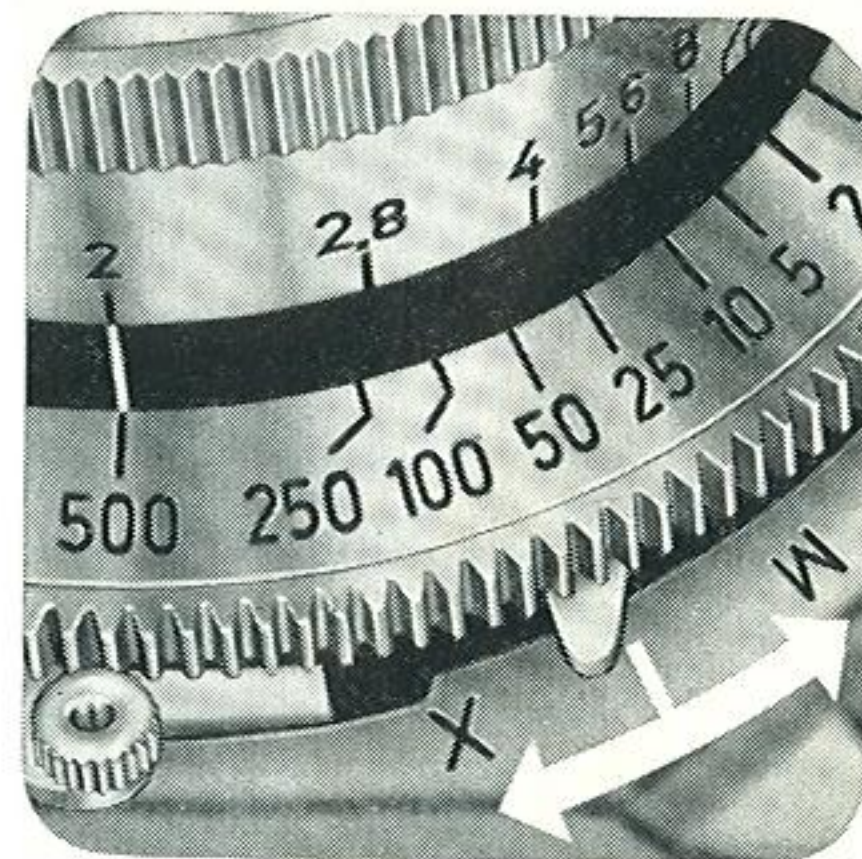

X Setting:

The contact closes at the instant when the shutter is fully open.

M Setting:

The contact closes a short time — corresponding to the firing delay of class M flash bulbs — **before** the shutter is open.

Shutter speeds with flash

Flashbulbs		Synchro-Lever Setting	
Make	Type	X	M
General Electric West Electric West Electric Sylvania West Electric	} SM SS SF	1 — 1/100	Not intended for M synchronization
Philips Osram Philips Osram General Electric Sylvania West Electric	PF 1 XM 1 PF 5 XM 5 } M-2 2-M	1 — 1/25	1/50 — 1/500
West Electric West Electric West Electric General Electric West Electric General Electric Sylvania Sylvania	0 3 } 5 P-5 } 8 25	1 — 1/25	1/50 — 1/500

Caution: The flash contact must not be used to fire bulbs from 110 or 220 volt electric mains.

Electronic Flash	Synchro-Lever Setting
Type	X
Instantaneous firing	1 to 1/500
5 ms delay	1 to 1/100

Voigtländer Focar Lenses

for standard 50 mm lenses

Do not miss this highly interesting field of photography which so many amateurs seem to neglect. Large-scale pictures of flowers, butterflies and other animals, small "objets d'art", etc. can yield extraordinarily beautiful results. With the Voigtländer Focar Lenses you can also copy without trouble pages from books, stamps, or small pictures.

The effect of Focar lenses can be explained by the fact that they shorten the focal length of the camera and make it possible to jump the normal 3½ feet barrier set by the standard camera lens. The range of distances for the different lenses is as follows:

FOCAR "A" 100 to 50 cm (39½" to 19¾")

FOCAR "B" 50 to 33.5 cm (19¾" to 13¼")

FOCAR "C" 29 to 22.5 cm (11½" to 9")

Detailed instructions for use and data for scale of reproduction, depth of field etc. are contained in a small brochure which we shall be pleased to supply on request.

Focusing table for FOCAR lenses

Camera distance scale set to:	Distance between the subject and the front of the FOCAR lens		
	FOCAR "A"	FOCAR "B"	FOCAR "C"
∞	3' 3½"	1' 7½"	11½"
60'	3' 1½"	1' 7"	11½"
○	2' 11½"	1' 6½"	11"
20'	2' 10"	1' 6"	11"
15'	2' 8½"	1' 5½"	11"
12'	2' 7"	1' 5½"	10½"
▽	2' 6"	1' 5"	10½"
10'	2' 5½"	1' 5"	10½"
8'	2' 4"	1' 4½"	10"
7'	2' 3"	1' 4"	10"
6'	2' 1½"	1' 3½"	10"
5'	2'	1' 3"	9½"
4' 6"	1' 10½"	1' 2½"	9½"
4'	1' 9½"	1' 2"	9"
3' 6"	1' 8½"	1' 1½"	9"

The Voigtländer Proximeter for standard 50 mm lenses and the 100 mm Dynaron

The special advantage of this ideal close-up attachment is that it permits hand-held near shots with the camera instantly ready for action – an important point with live or other rapidly moving subjects. At the same time the viewfinder parallax error is automatically corrected, and even at closest range the eye views the image as at infinity.

The Proximeter achieves this with the aid of two firmly connected supplementary lenses. One is a positive meniscus lens and fits over the camera lens, while the other is a prismatic element to converge the rangefinder rays. This necessarily couples the camera lens and rangefinder just as precisely for close-range shots as normally for subjects from 3¼ feet to infinity.

The PROXIMETER close-up attachment is available in two focal lengths and covers a focusing range from 37 to 9¾ inches. A copy of the special PROXIMETER leaflet with detailed instructions will be sent on request.

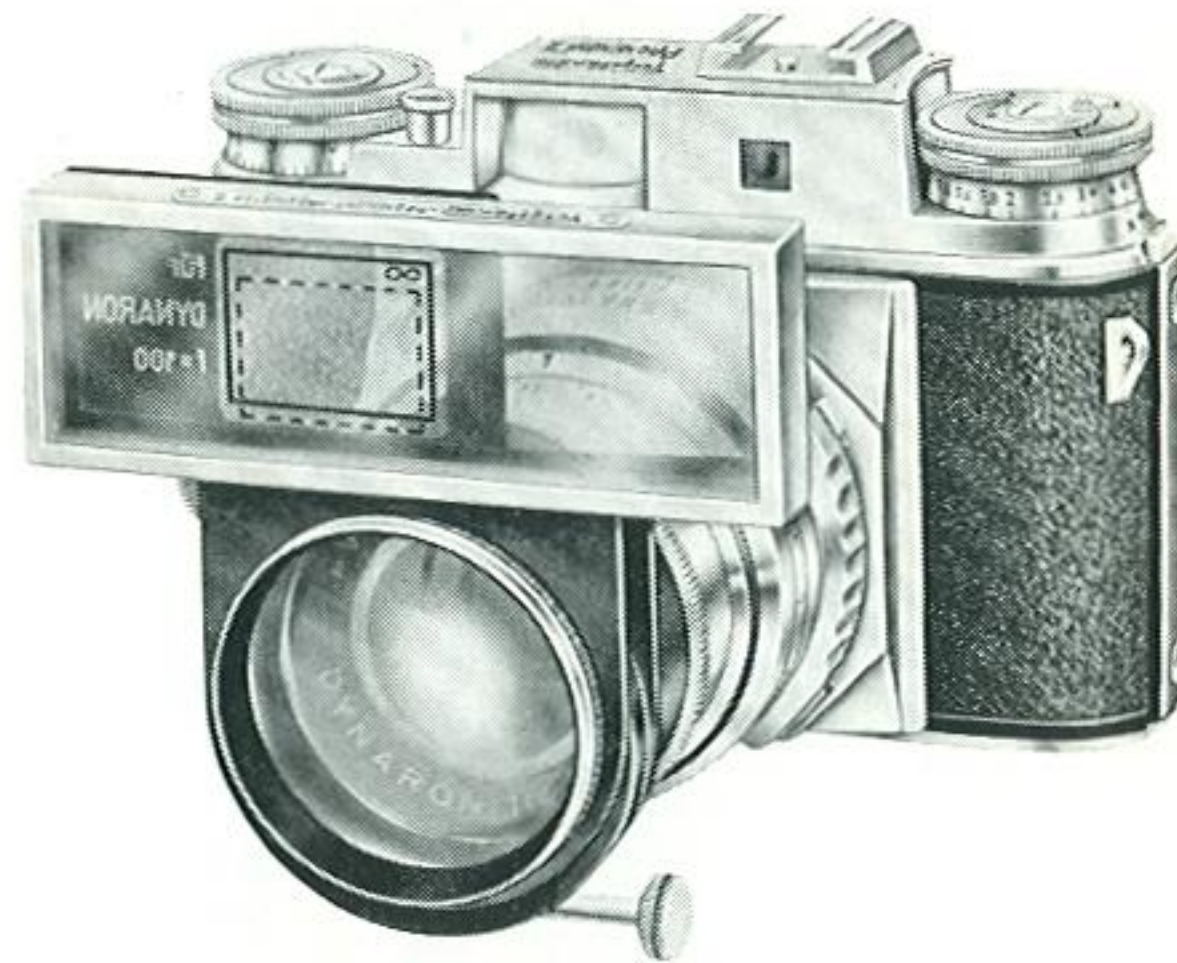

Scale of Reproduction and Size of Subject in inches

	distance				
	3' 1"	2' 6"	1' 7½"	1' 1"	9½"
f = 50 mm	1 : 18.1 1'5" x 2'1½"	1 : 14.1 1'2" x 1'9"	1 : 9.4 8½" x 1'1½"	1 : 6.4 6" x 9"	1 : 4.8 4½" x 6½"
f = 100 mm	1 : 9.5 9" x 1'1½"	1 : 7.7 7" x 10½"	1 : 5 4½" x 7"	1 : 3.3 3" x 4½"	1 : 2.5 2½" x 3½"

Copying and close-ups

with the Voigtländer copying outfit.

The copying outfit with the 2 inch. (50 mm) Repro-Skopar f/3,5 in focusing head can be universally used for professional and scientific photography as well as for amateur purposes. It ideally combines great stability and absolute rigidity with multiple utility.

For the field of documentation the copying outfit permits quick and easy large-scale reproductions of small subjects (stamps etc., pages of books, letters, documents, drawings of all sizes between 74 x 105 mm (approx. 3 x 4³/₈ inch.) and 297 x 420 mm (approx. 11¹/₂ x 16 inch.) in vertical direction. With the copying outfit assembled as multi-purpose table tripod it is also possible to copy subjects up to a size of 349 x 523 mm (13³/₄ x 20¹/₂ inch.) in horizontal direction.

Close-ups of plastic subjects (blossoms, coins, minerals, interesting insects etc.) are made really easy with the ground glass adapter, which excludes parallax error and with 5 x magnifier, furthermore with the continuous focusing of the Repro-Skopar from 70,9—14,6 mm (22³/₄—5³/₄ inch.), achieving scales of reproduction from 1 : 14,5 to 1 : 3.

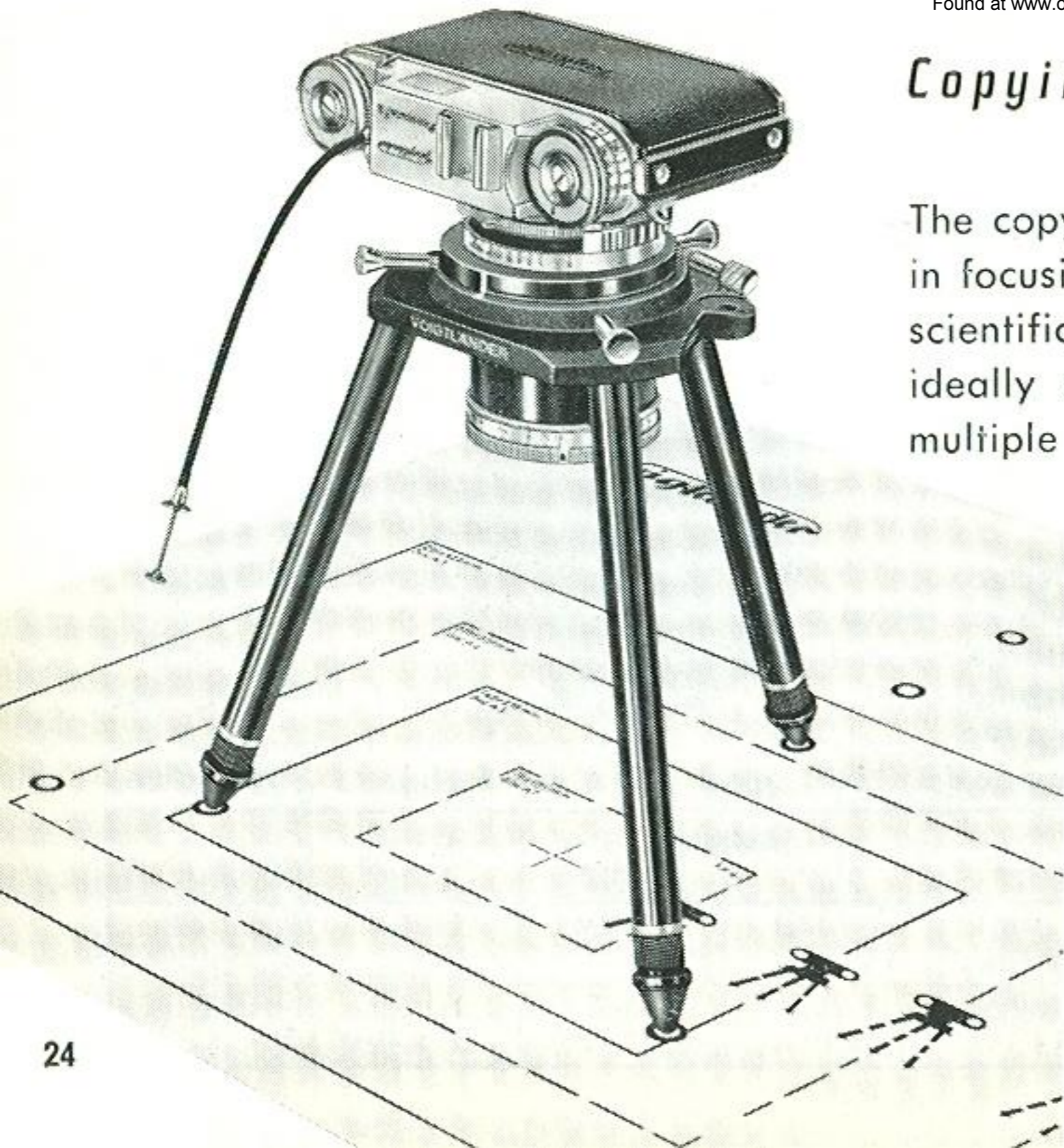

Macro-Photography 1:1 and 2:1

with the Voigtländer Macro Unit

The macro unit is a very useful addition to the Prominent system of accessories for close-ups (i. e. the Focar lenses, Proximeter, and copying outfit).

With this handy and reliable unit flat objects as well as subjects of slight depth are easily reproduced in natural size or magnified 2 times on the film. It is particularly suitable for optical same-size printing of black-and-white and colour negatives and transparencies.

The 24 x 36 mm. PROMINENT II miniature camera thus becomes an ideal tool for certain and instant use in all professional and scientific fields, or for private purposes where natural size or 2 times magnified pictures are required. Applications include forensic work (photographing finger-prints, forgeries, and other clues), medical photography, botany, technology, examination of handwriting, philately, and many others.

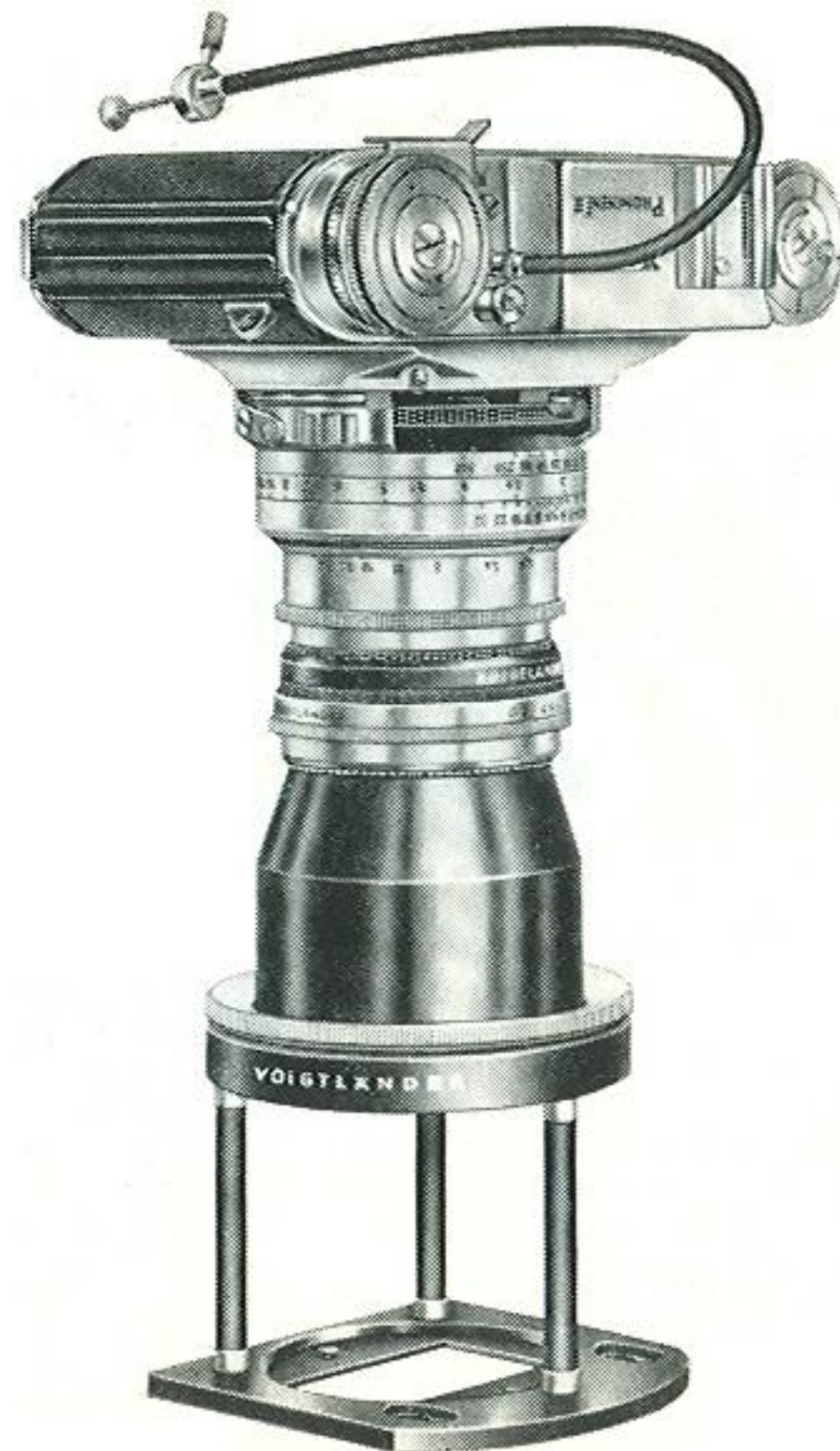

Photomicrographs

of prepared and live specimens are widely used in science and technology, and are the basis for study and research in medical and experimental establishments, academeical as well as industrial.

Compared with photomicrographs taken on sheet films or plates, work with the PROMINENT II offers decided advantages of not inconsiderable weight:

- The micro accessories are not costly; they are handy, quickly assembled, and permit photomicrography on even the smallest desk.
- With miniature film series of up to 36 black and white or colour photographs can be taken in rapid sequence and with short exposures, as for instance when observing crystallisation, or biological and other processes.
- Filing and storage of a large number of photomicrographs occupies the smallest possible space.
- The cost of 35 mm. miniature film is low, an important consideration particularly with colour material.

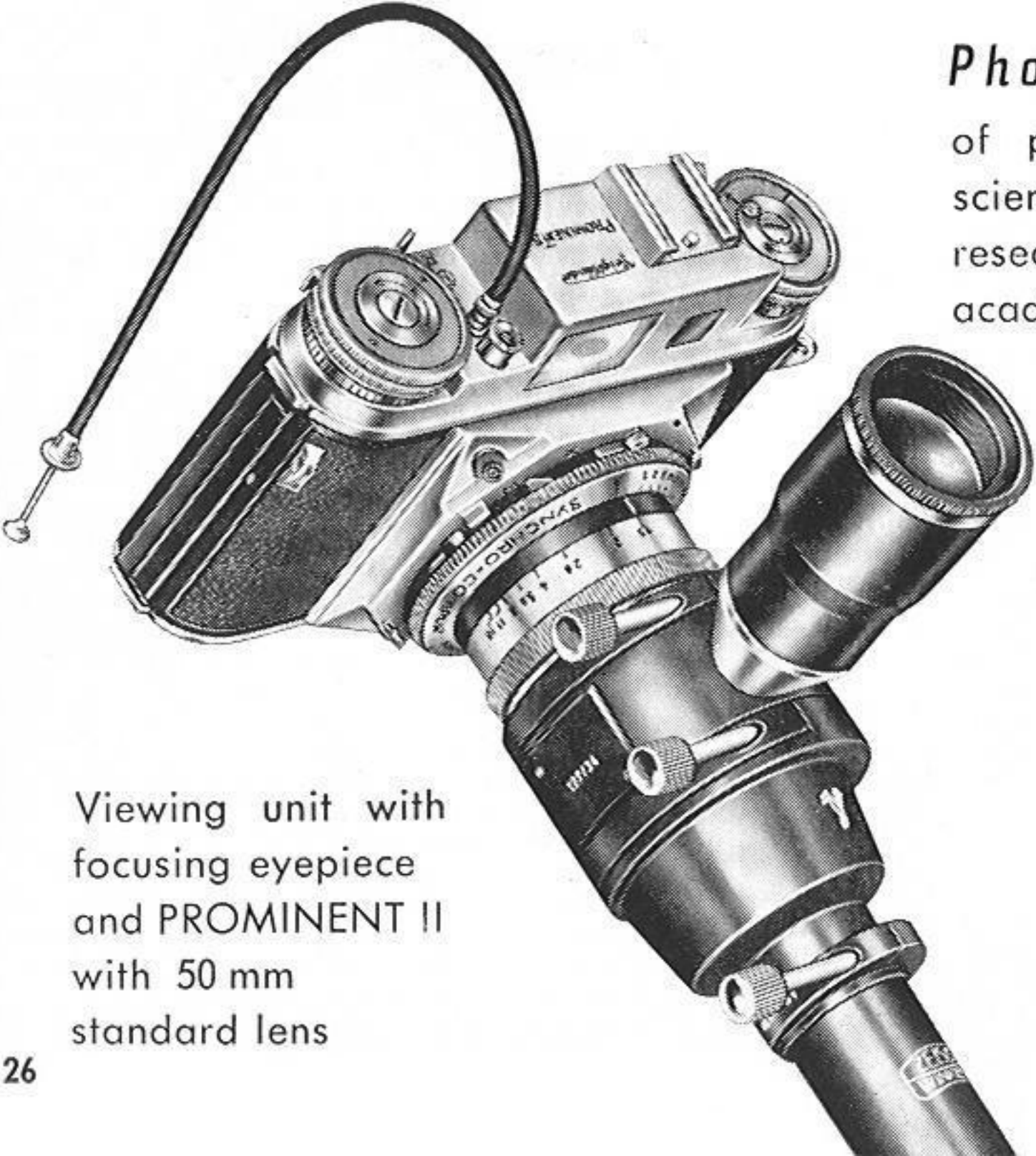

Viewing unit with focusing eyepiece and PROMINENT II with 50 mm standard lens

Voigtländer Turnit-3-finder

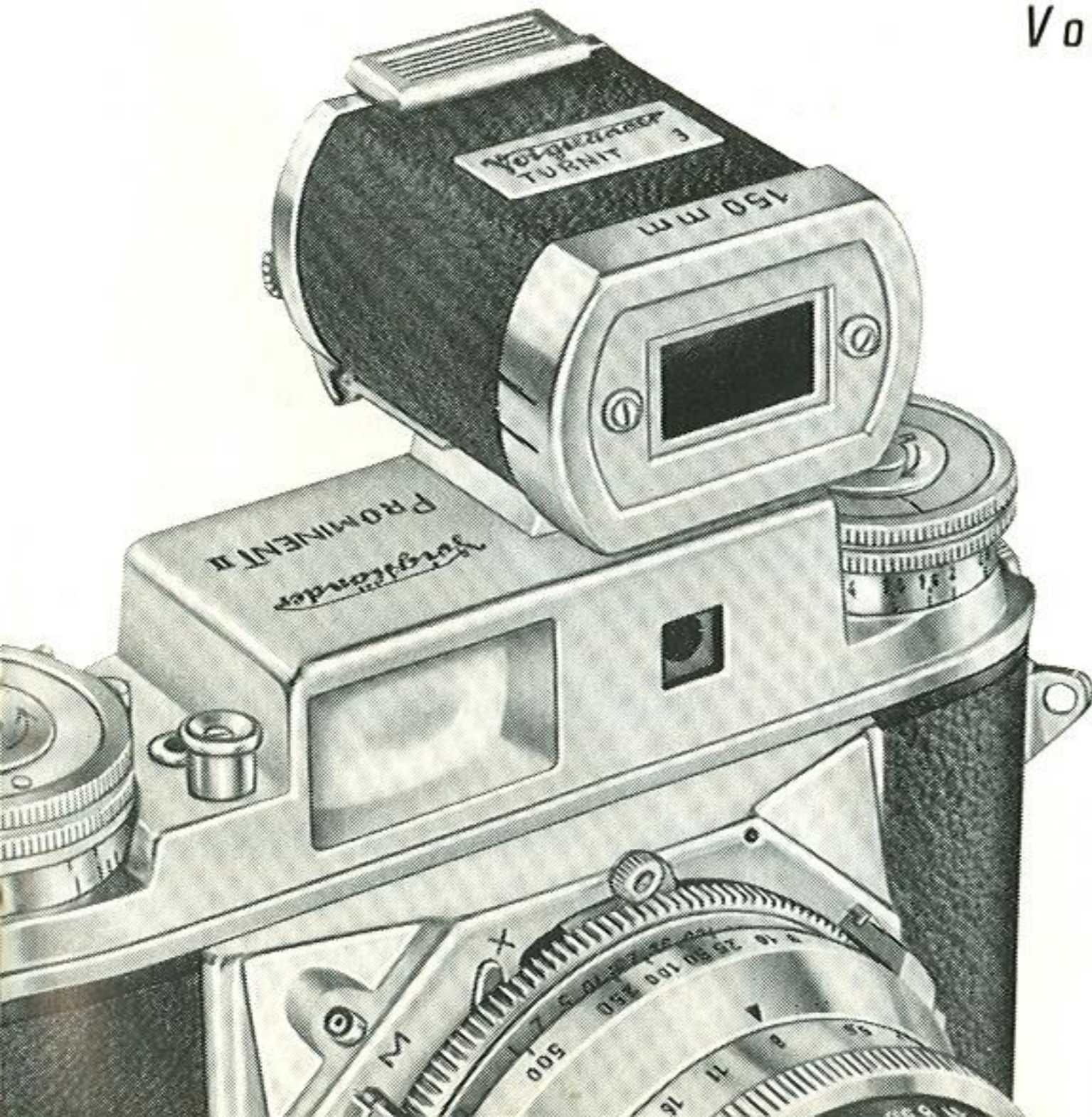

This additional finder yields bright, clean images for each focal distance from 35 mm. to 150 mm. and further incorporates parallax compensation. When used for telephoto lenses the image is magnified 1.7 times – which is very convenient when taking distant subjects.

The finder can be used in two directions: for standard lenses 50 mm. and – after folding down the mask “35 mm.” – for the Skoparon 35 mm. Swinging the eyepiece out of the way and turning the whole finder through 180 degrees converts it to the correct angle of view for the Dynaron 100 mm. For the Super-Dynaron 150 mm. simply push the mask “150 mm.” over the frame (see ill.).

Voigtländer Filters

are made of spectroscopically tested glass, dyed in the mass, and coated to reduce reflections. The filter factors given below are approximate values, as they necessarily depend on the colour sensitivity of the black-and-white film used, and on the light conditions prevailing at the time of the exposure.

- | | |
|-------------------------------|---|
| Yellow Filter G 1.5 x | Slight filtering effect for outdoor shots requiring short exposures, such as sports and action subjects, and pictures with low sun.
Filter factor: 1½ times. |
| Yellow Filter G 3 x | Universal filter for landscapes and other outdoor subjects; indispensable for snow pictures.
Filter factor: 3 times. |
| Green Filter Gr 4 x | Lightens green tones in landscapes. Recommended for artificial light portraiture and copying of coloured originals.
Filter factor: 4 times. |
| Orange Filter Or 5 x | Strong filter effect through appreciable suppression of blue. Reduces atmospheric haze in distant views.
Filter factor: 5 times. |
| Ultra-violet Filter UV | Cuts out ultra-violet radiation in high mountains or near the sea. Eliminates any unpleasant blue cast in colour shots. Needs no exposure increase. |
| Polarizing Filter P | Cuts down or eliminates disturbing reflections from shiny surfaces, such as glass, water, or varnish, but not metallic surfaces.
Filter factor: 2,5 x, with stronger reflections 4—5 x. |

Shots against the light

are among the finest and most rewarding of photographs. People and objects show a sparkling rim of light; the shadows point towards the camera and convey an impression of depth which cannot be obtained with any other lighting.

However, shots against the light need a lens hood. It allows only those light rays to reach the lens which you need for your picture and it keeps out troublesome stray light, which may come from the sun, the sky, water, or an artificial light source. It can cause slight reflections, decrease definition and reduce contrast, notwithstanding the coated lenses.

The lens hood is not only indispensable for shots against the light and with artificial light, but also protects the lens from rain or snow during bad weather.



Always fit the lens hood so that the flat sides are parallel with the camera top to avoid vignetting.

Aperture and depth of field

The depth of field of a picture is the part of the view in front of, and behind, the focused distance which is still reproduced sharply on the film.

The depth of field is, however, not constant. It becomes greater the more the lens is stopped down, and it decreases as you open the aperture. So remember:

- **Large apertures** (e. g. f/4) = **produce little depth of field,**
- **Small apertures** (e. g. f/11) = **produce great depth of field.**

You can read off the depth of field (with 50 mm lenses only) for each exposure from the depth of field and it decreases as you open the aperture. So remember:

When the rangefinder is sharply focused, the ▲ mark points to the exact subject distance. The focusing knob also carries two series of aperture numbers symmetrically grouped to the left and right of the distance mark, with the distance scale immediately above. The depth of field always extends from the distance above the aperture number chosen on the left to the distance above the corresponding aperture number on the right (see

Care of camera and lenses

Successful results and long life of your camera depend largely on proper care and correct handling. Therefore always treat the camera very gently and never use force. If you are doubtful on any point, have another look at the appropriate section of these instructions. If the camera appears to have a fault show it to your dealer or post it to

VOIGTLÄNDER A.G. BRAUNSCHWEIG (GERMANY), Dept. Service VA.

For cleaning the lens we recommend a small patch of soft cloth free from fluff or special lens cleaning tissue. Large specks of dust or grains of sand from the beach must first be carefully removed with a soft brush; finger prints and similar grease stains must be wiped off with a piece of cotten wool moistened with alcohol or ether.

Every *Voigtländer* PROMINENT II

and every interchangeable lens has its serial number. You will also find the lens number on the test certificate which is enclosed with every Voigtländer high efficiency anastigmat. Should the camera or a lens get lost, a knowledge of the serial numbers may help in recovering it.

We Guarantee

this camera against defects due to faulty materials or workmanship according to the present standard of technical perfection. Should any such defects become apparent in use they will be rectified free of charge if the claim is made within a reasonable period after purchase. Claims for further damages, consequential or otherwise, or for the free repair of faults due to incorrect handling or storage cannot be recognised.

VOIGTLÄNDER A. G. BRAUNSCHWEIG



Your Photo Adviser:

PROMINENT II