



MINOLTA

E INSTRUCTION MANUAL

DYNAX™

8000i

Thank you for purchasing this camera. Its design is based on state-of-the-art AF SLR technology, and we hope that it will provide you with many years of satisfying results.

Pressing the camera's program-reset button readies it for completely automatic operation. Beyond this, Dynax 8000i allows for customization of six primary functions: focus mode, autofocus area, exposure mode, metering mode, exposure adjustment, and film-advance mode. A single switch is used for changing the focus mode, while the other five functions are selected using the camera's setting control in combination with the appropriate button. At any time in the course of operation, all settings can be returned to their standard positions by pressing the camera's program-reset button; in addition, the focus mode is reset to AF each time the camera is switched on.

Please take the time to read through this manual and learn about the 8000i's various features, and then keep it handy for future reference; doing so will allow you to take full advantage of your new camera, right from the start.

NAMES OF PARTS

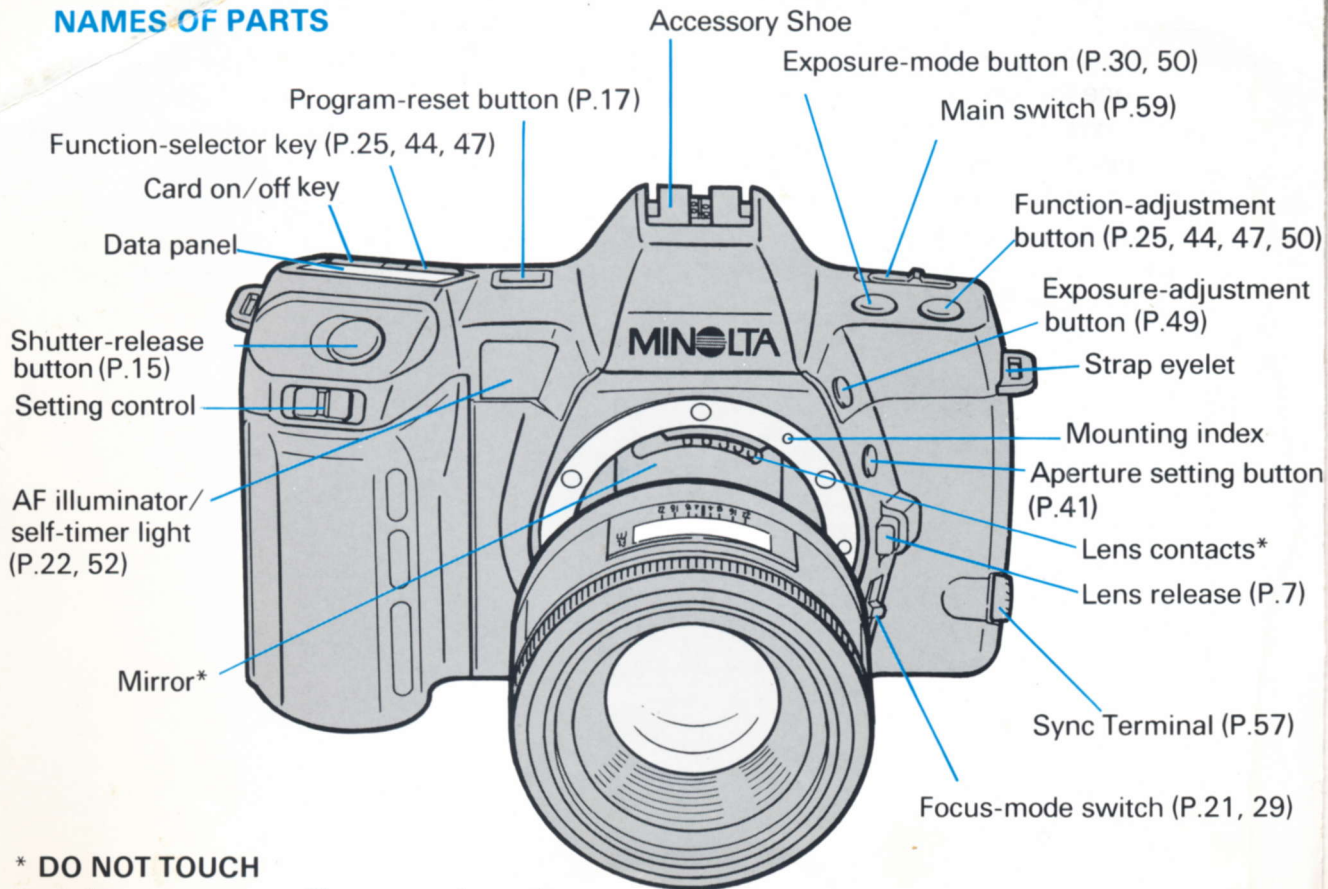

* DO NOT TOUCH

For information on specific parts, refer to the page numbers shown in parentheses.

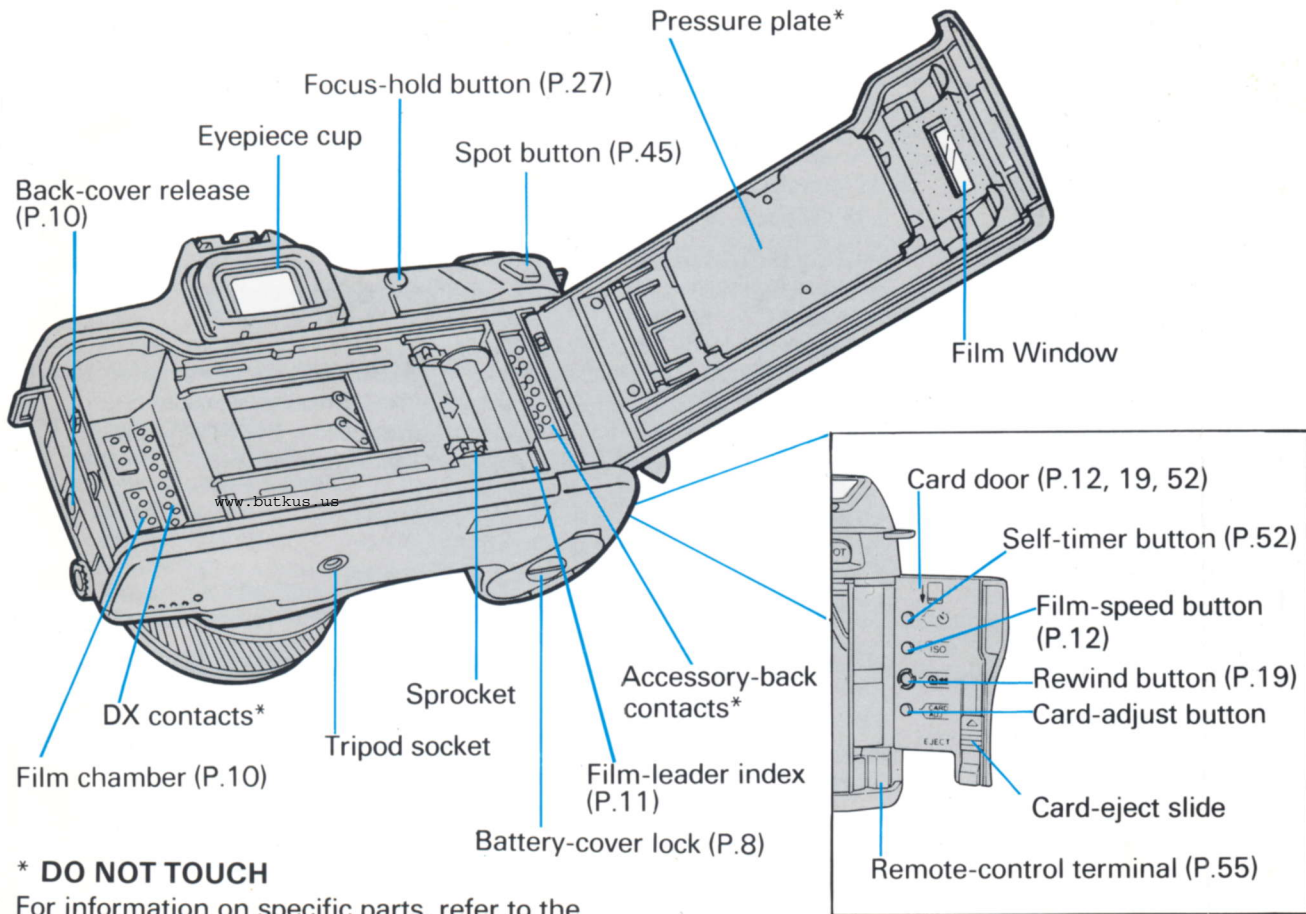

*** DO NOT TOUCH**

For information on specific parts, refer to the page numbers shown in parentheses.

TABLE OF CONTENTS

Data Panel and Viewfinder Displays	2
Summary of Operation	4

GETTING STARTED

1. Preparing the Camera

Attaching and Removing the Lens	6
Power	8
Battery Installation	8
Battery-Condition Indicators	9
Film	10
Film Loading	10
Automatic Film-Speed Setting	12
Setting the Film Speed Manually	12

2. Basic Operation

Holding the Camera	14
Shutter-Release Button	15
Taking a Picture	16
Program Reset	17
Film Rewind	18
Automatic Film Rewind	18
Manual Start of Film Rewind	19

OPERATION IN DETAIL

3. Focus

Basic Information and Mode Selection	21
Autofocus	21
Operation and Viewfinder Focus	
Signals	21
Focus-Area Selection	24
Focus Hold	26
Special Focusing Situations	28
Manual Focus	29

4. Exposure

Basic Information and Mode Selection	30
--	----

P: Program Mode	32
Program Shift	33
A: Aperture-Priority Mode	35
S: Shutter-Priority Mode	38
M: Manual Mode	40

5. Metering

Basic Information	42
Mode Selection	44
Multi-Pattern and Centerweighted-	
Average Metering	44
Spot Metering	45

6. Film Advance

7. Exposure Options

Exposure Adjustment	48
Multiple Exposure	50
Self-Timer	52
Long Exposures	54
Flash Photography	56

8. Additional Information

Main Switch	59
Cold-weather Operation	59
Battery Performance	59
Attaching the Neckstrap and Eyepiece	
Cap	60

9. Troubleshooting

Accessories	64
-------------------	----

Appendix

Operation Chart	78
Viewfinder and Data Panel Exposure	
Warnings	79

Technical Details

Care and Storage	84
------------------------	----

DATA PANEL

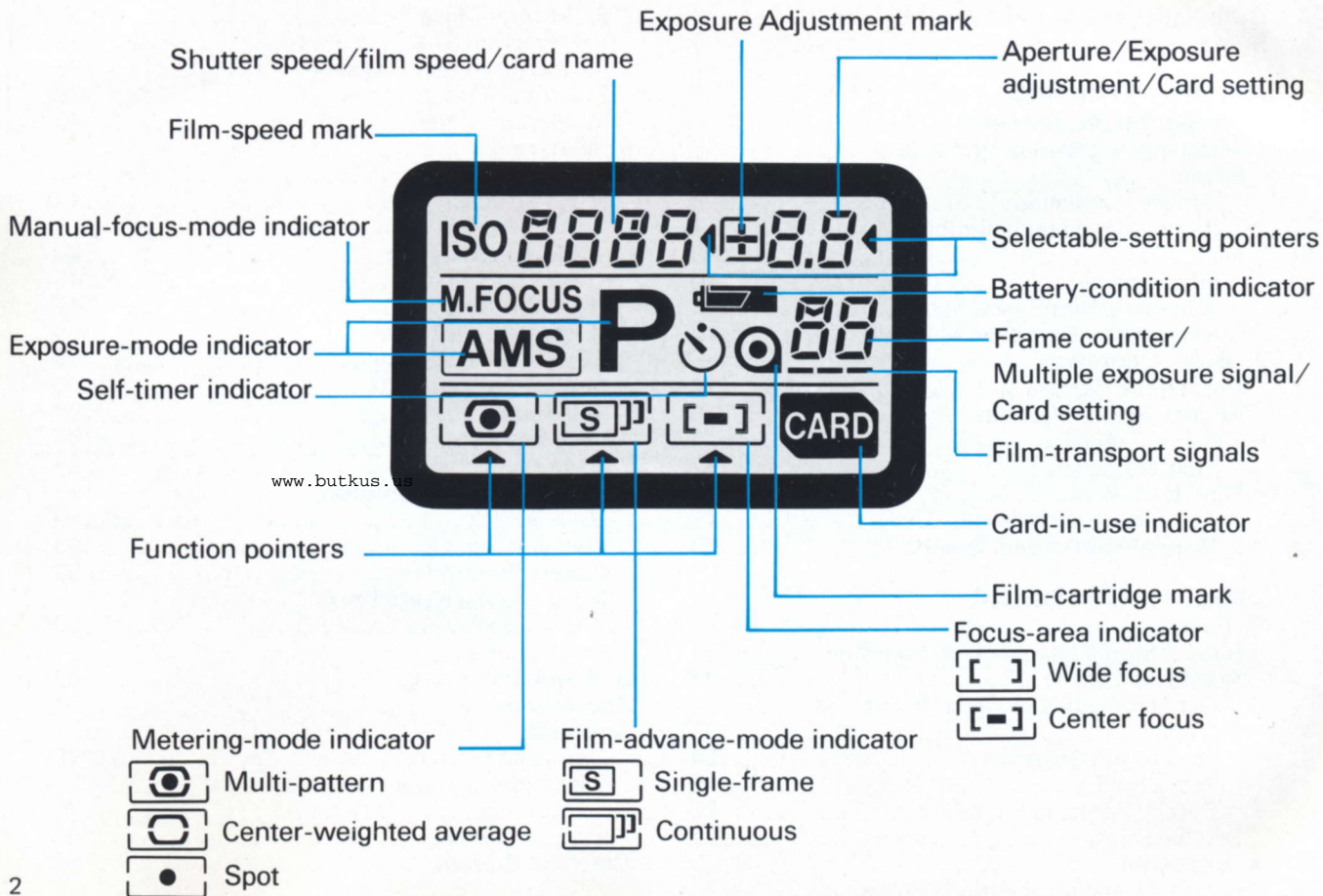

VIEWFINDER

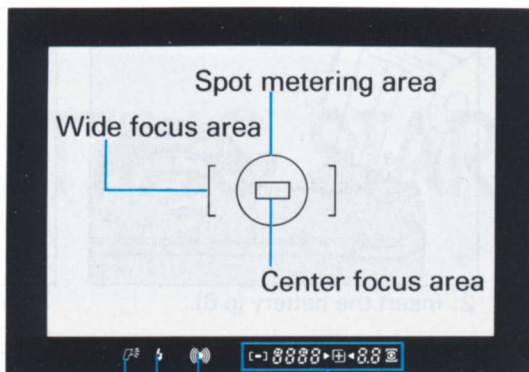

Flash-on signal

Flash-ready signal

Focus signal

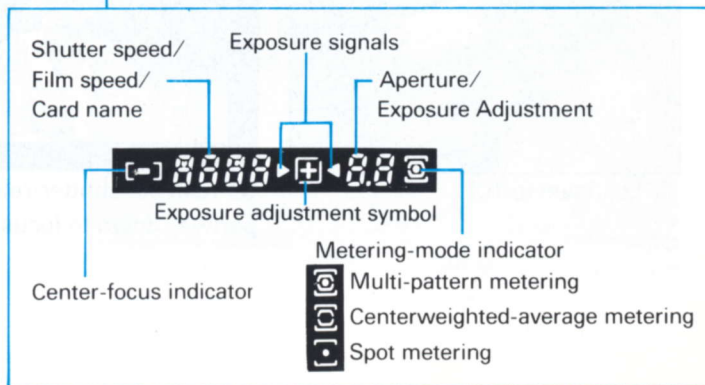

SUMMARY OF OPERATION

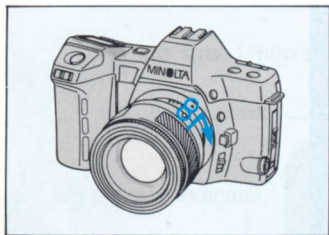

1. Attach the lens (p.6).

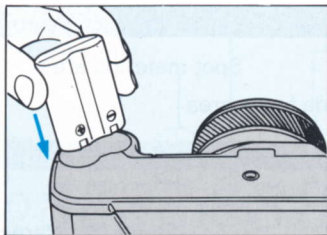

2. Insert the battery (p.8).

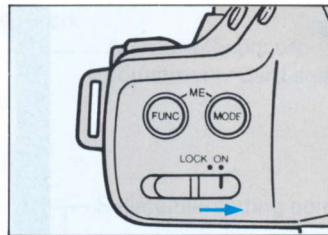

3. Move the main switch to **ON** (p.59).

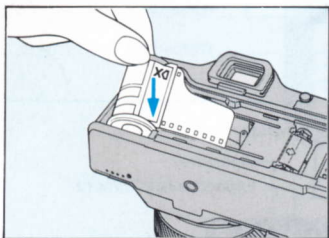

4. Load film (p.10).



5. Press the shutter-release button partway down to focus (p.16).

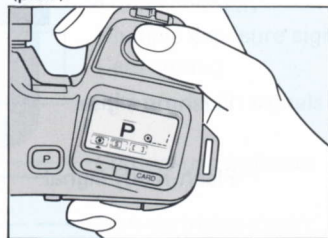

6. Press the shutter-release button all-the-way down to take the picture (p.17).

GETTING STARTED

Preparing the Camera Basic Operation



1. PREPARING THE CAMERA

ATTACHING AND REMOVING THE LENS

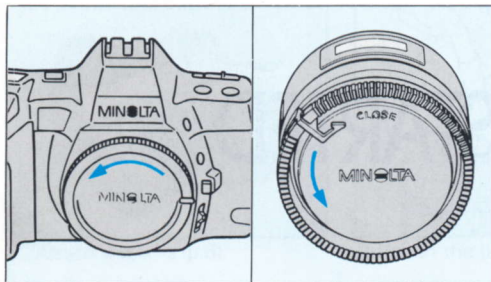

To attach:

1. Remove the body and rear lens caps, as shown.

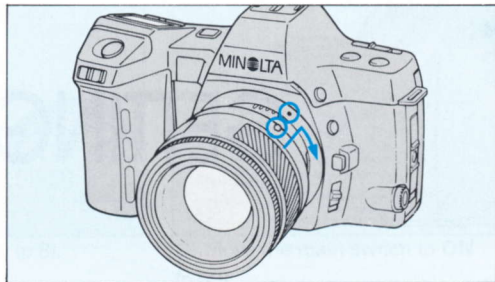

2. Align the red bead on lens barrel with the red dot on camera's lens mount. Insert the lens bayonet into the mount and turn the lens clockwise until it locks in place with a click.

When attaching or removing lenses, be careful not to touch anything inside the camera, especially the lens contacts or mirror. To protect the lens contacts and elements, attach the lens caps whenever the lens is not in use.

If lens is not attached properly, -- appears in the data panel's aperture display when camera is switched on.

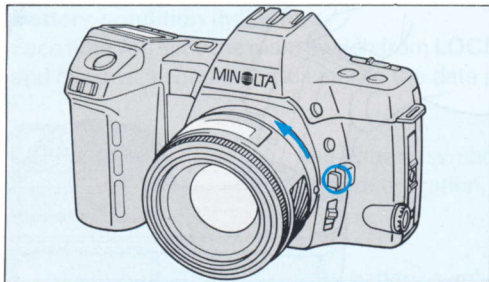

To remove:

1. While pressing the lens release, turn the lens counterclockwise as far as it will go, then lift lens out of mount.
2. Attach another lens or the body cap to prevent dust from entering the camera.

Care of Glass Surfaces

- Never touch lens elements or the camera's eyepiece with your fingers. If the lens becomes dirty, clean it gently with a lens brush. Only if necessary, moisten a sheet of lens tissue with one drop of lens-cleaning fluid and, starting at the center and using a circular motion, lightly wipe the surface of the lens.
- Never lift the mirror or touch its surface, since this may impair its alignment. Dust specks on the mirror's surface will not effect exposure or picture quality. If dust on the mirror is distracting, the camera can be cleaned at an authorized Minolta service facility.

POWER

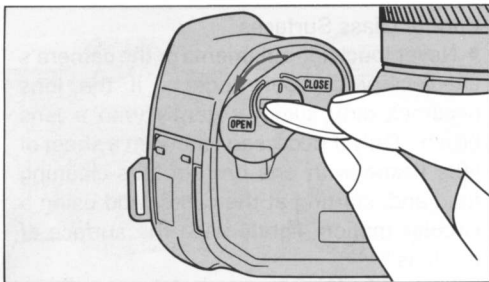

This camera uses a 6-volt 2CR5 lithium battery that supplies power for all camera operations.

Battery Installation

1. With the main switch at **LOCK**, use a coin or similar object to turn the battery-cover lock to the **OPEN** position. Remove the battery cover.

If necessary, wipe the battery terminals with a dry cloth to ensure proper contact.

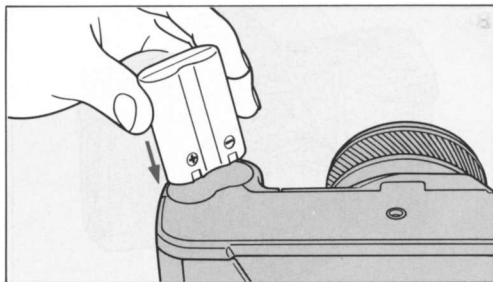

2. Insert the battery according to the marks in the battery compartment.





3. Replace the battery cover and turn the battery-cover lock to the **CLOSE** position.

CAUTION

- Do not disassemble or short-circuit the battery or subject it to high temperatures or fire. The battery may explode or cause burns.
- Read and follow all warnings and instructions supplied by the battery manufacturer.
- Keep batteries away from young children.

Battery-condition indicators

Each time you slide the main switch from **LOCK** to **ON**, the camera automatically checks the battery and displays a condition indicator in the data panel:

- 1  _____ Full-battery symbol appears for five seconds: Power is sufficient for camera operation.
- 2  _____ Low-battery symbol appears for five seconds: Power is sufficient but getting low— **keep a fresh battery handy.**
- 3  _____ Low-battery symbol blinks: Camera can be operated, but the **battery will need to be changed soon.**
- 4  _____ Blinking low-battery symbol alone, or no display at all appears, and the shutter cannot be released: Power is too low for normal operation— **replace the battery.**

In cases 3 and 4, the battery-condition indicator appears whenever the shutter-release button is pressed down. If no display appears when the main switch is set to **ON**, double-check that the battery is inserted correctly before inserting a fresh one.

FILM

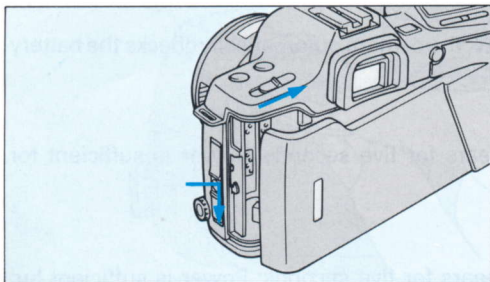

Film Loading

1. Slide the main switch to **ON**.
2. Open the back cover by sliding the back-cover release downward. (**When loading film for the first time**, remove and discard the protective plastic cover that is attached to the pressure plate.)

- Before opening the back cover, check that **0** is displayed in the frame counter; if not, film is already loaded and the camera should not be opened. The type of film loaded can be verified by checking the film window. (For instructions to rewind a partially exposed roll of film, refer to pg. 19).
- Always load film in subdued light, or at least shaded from direct sunlight.

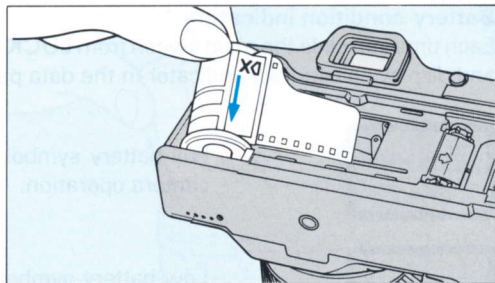

3. Place the film cartridge into the film chamber, as shown.

RIGHT

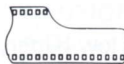

WRONG

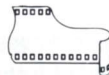

Make sure the tip of the film is correctly shaped. Otherwise, the film may not wind properly.

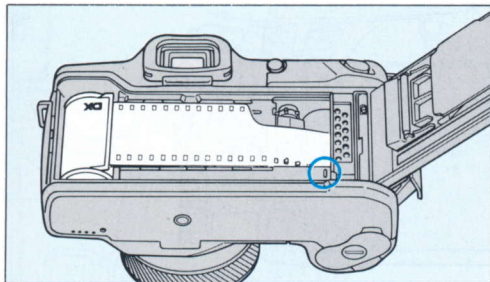

4. Extend the tip of the film past orange mark. Make sure the holes in the lower edge of the film engage the teeth on the sprocket.

RIGHT

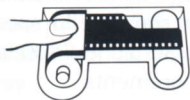

WRONG

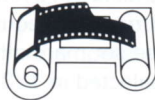

If the film extends too far or does not lie flat, gently push the excess back into the cartridge.

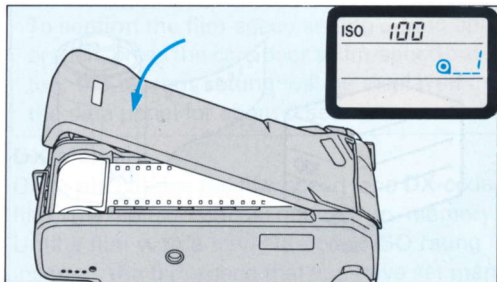

5. Close the back cover so that it snaps shut. The camera will automatically wind the film to the first frame, and 1 will appear in the frame counter.

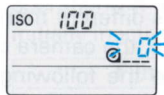

If the film is incorrectly loaded, the frame counter remains at 0 and blinks, and the shutter locks. Remove the film and repeat steps 3 to 5.

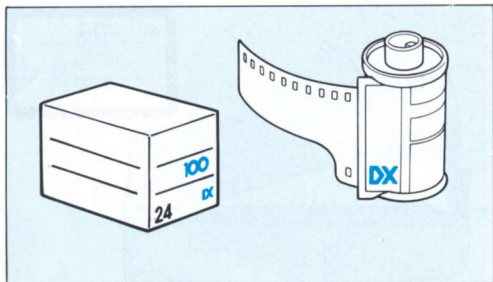

Automatic Film Speed Setting

The film speed is set automatically for ISO 25-5000 DX-coded films. When loading film, be sure to confirm the ISO setting, which will be displayed briefly in the data panel. If the film speed set for a DX-coded film is different than that printed on the film cartridge, the camera's DX-memory is active. Refer to the following page for details on the DX-memory feature.

If you use film that is not DX coded, the previous film speed setting will be retained; initially, this value is set to ISO 100. Instructions for setting the film speed manually are given in the next column.

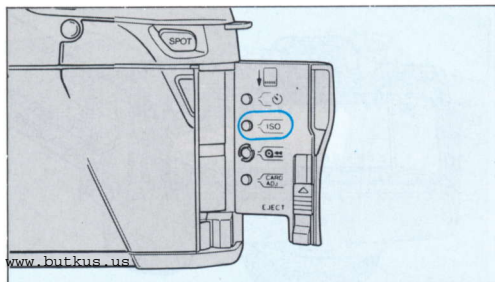

Setting the Film Speed Manually

If desired, you can manually override the DX-coded film speed and reset the film speed to a higher or lower value. Also, if you are using a film that is not DX coded, this control should be used to set the required film speed. Film speeds can be set manually from ISO 25 to 6400, and are selected in 1/3 stop increments.

To set the film speed manually:

1. Open the card door on the right side of the camera.
2. Press and release the film-speed button. The current film-speed setting will be displayed in the data panel, beside the film-speed mark (ISO).

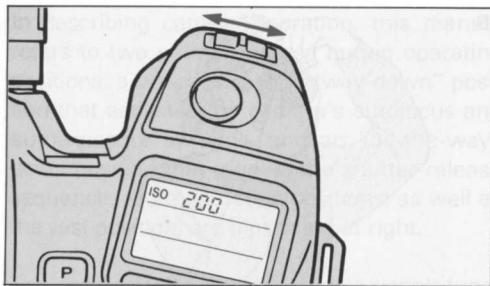

3. Move the setting control right to increase the film speed, or left to decrease it. Holding the control in either direction causes the film speed to change continuously.

4. When the film speed that you want to set appears in the data panel, press the shutter-release button lightly to restore the operating display.

If step 4 is omitted, the film speed currently displayed in the data panel is set, and the operating display returns within 5 seconds.

To confirm the film-speed setting during operation, press the card door's film-speed button: the current setting will be displayed in the data panel for about 5 sec.

DX Memory

Once you change the film speed for a DX-coded film, the adjustment is retained in memory. Until a film with a new DX-coded ISO rating is inserted, the film speed that you have set manually will be automatically applied to all film subsequently loaded. Once a film with a new DX-coded ISO rating is inserted, the film-speed memory will be erased.

The following sequence illustrates DX-memory operation. It assumes that the DX-memory is initially inactive.

Film Operation	ISO Setting
1. DX-coded ISO 100 film loaded	100
2. Film speed manually reset to ISO 50	50
3. DX-coded ISO 100 film loaded	50
4. DX-coded ISO 200 film loaded	200
5. DX-coded ISO 100 film loaded	100

2. BASIC OPERATION

HOLDING THE CAMERA



To obtain sharp, blur-free photos, hold the camera as still as possible and steady it against your face or body. To take pictures, press the shutter-release button gently with a slow, steady squeeze— never a quick jab.



Two recommended ways of holding the camera are shown here. If you grasp the camera firmly with your right hand on its handgrip, you can shift the camera back and forth for horizontal (A) and vertical (B) pictures without removing your hands from the controls. When using auto-focus, make sure not to touch the lens focusing ring or AF illuminator.

SHUTTER-RELEASE BUTTON

In describing camera operation, this manual refers to two shutter-release button operating positions: a pre-release, "partway-down" position that activates the camera's autofocus and autoexposure systems, and an "all-the-way" down position that triggers the shutter-release sequence. Both operating positions, as well as the rest position, are illustrated at right.

The viewfinder focus and exposure signals function when the shutter-release button is pressed partway down, whether you operate the camera in automatic or manual mode. In manual mode, they can assist you in setting focus and/or exposure.

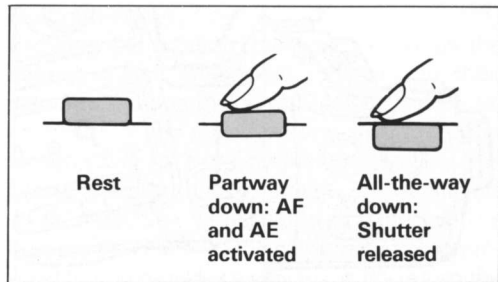

In standard operation, described in the following section, focus and exposure are set when the shutter-release button is pressed partway down; autofocus-integrated metering ensures that exposure is correct for the subject that you focus on.

TAKING A PICTURE

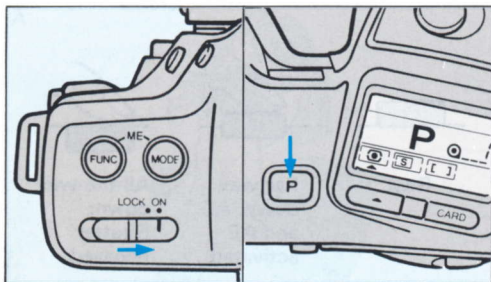

This section describes the simplest way to operate the camera.

1. Slide the main switch to **ON**, then press the program-reset button to set the camera for fully automatic operation.
2. Hold the camera firmly with your right hand on its handgrip and support the lens with your left hand.

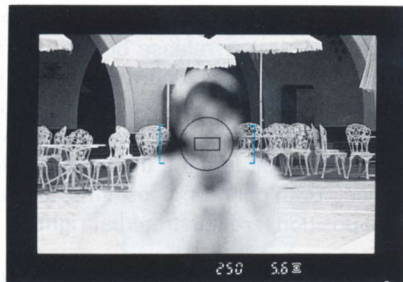

3. While looking through the eyepiece, center the focus frame on your subject and gently press the shutter-release button partway down to focus.



4. When the green focus signal glows, press the shutter-release button all-the-way down to take the picture.

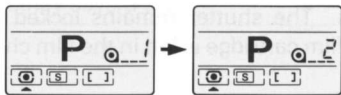

After the picture is taken, the film is automatically advanced and the frame counter increases by one.

If the red rather than the green focus signal blinks, focus the lens manually. Refer to the focusing section for more information.

Program Reset

Pressing the program-reset button brings the camera's main selectable functions to their standard settings, including autofocus and auto-exposure. If you are a first-time user and want to get a feel for the way the camera operates before learning about its functions in detail, this is an easy way to get started. Once you've become familiar with the camera, the program-reset button provides a way to rapidly return the camera to standard operation, useful for when you're through with a setting configuration adopted for a particular shooting situation.

Whenever the program-reset button is pressed, the camera is set to autofocus mode, wide focus area, program exposure mode, multi-pattern metering, single-frame advance mode, ± 0.0 exposure adjustment; also, self-timer and multiple exposure functions will be canceled if previously set.

FILM REWIND

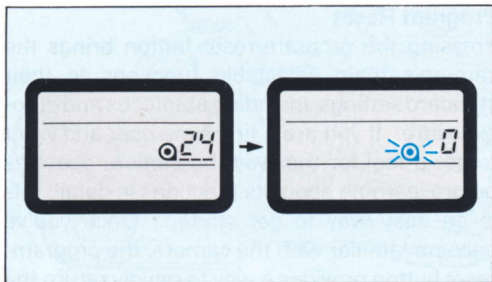

Automatic Film Rewind

After the last frame on the roll is exposed, the camera automatically starts rewinding the film. With a fresh battery loaded in the camera, it normally takes 8 seconds to rewind a 24-exposure film. While rewind is in progress, the frame counter displays the frame number of the last exposure.

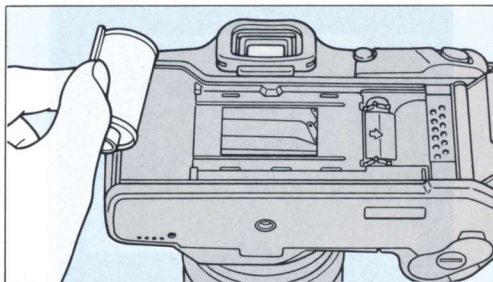

When film rewind is complete, the frame counter displays **0** and the data panel's film-cartridge mark blinks to indicate that the film cartridge can be removed. Open the camera back and remove the film. The shutter remains locked if a re-wound film cartridge is left in the film chamber.

If it's necessary to change batteries before rewind is complete, press the rewind button to restart after the new battery is installed.

The film leader will be wound all the way into the cartridge. If you want the film leader to be left out after the film is rewind, you can use the Customized Function Card to change this function. See p. 64 for more details about this and other Creative Expansion Cards.

If you accidentally open the camera back before the film is rewind, close it immediately. Press the rewind button to finish rewinding the film. Light falling on the film will ruin many of the pictures, but your quick action may save a few.

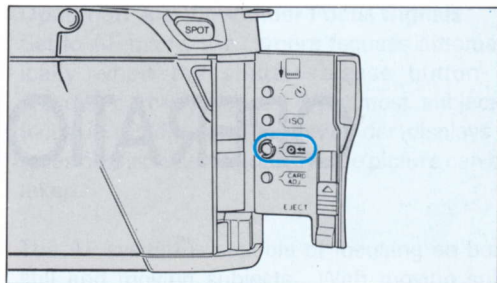

Manual Start of Film Rewind

You can also rewind and remove a roll of film before the last picture is taken. To start film rewind manually, simply open the card door on the right side of the camera and press the rewind () button.

OPERATION IN DETAIL

Focus
Exposure
Metering
Film Advance
Exposure Options
Additional Information



BASIC INFORMATION AND MODE SELECTION

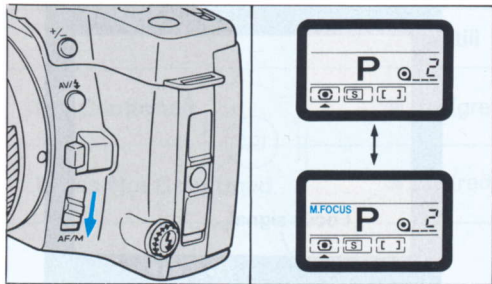

While either autofocus or manual focus can be selected, autofocus is the camera's standard focusing mode, and is set each time the camera is switched on.

To change the focus mode, slide the focus-mode switch downwards and then release it; spring action returns the switch to its rest position, and the new focus mode will be set. Whenever manual focus mode is selected, **M.FOCUS** is displayed in the data panel.

AUTOFOCUS (AF)

Operation and Viewfinder Focus Signals

Set to AF mode, the camera focuses automatically when the shutter-release button is pressed partway down. With most subjects, focus is rapidly set: the viewfinder displays a focus confirmation signal and the picture can be taken.

The AF system is capable of focusing on both still and moving subjects. With moving subjects, focus is adjusted continuously according to changes in subject position; in addition, Predictive Focus Control improves autofocus operation for moving subjects that are approaching the camera by automatically compensating for the change in subject position that occurs during the shutter-release sequence.

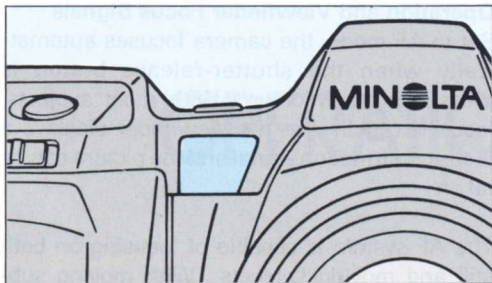



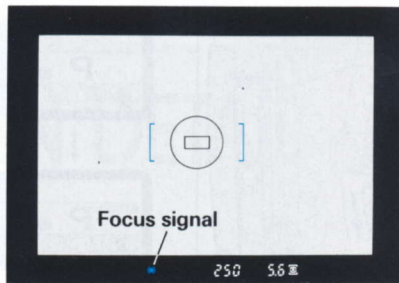

Autofocus itself depends on the detection of subject contrast by the AF system. For low light, low contrast subjects, the camera's AF illuminator is automatically activated when the shutter-release button is pressed partway down; by projecting a beam of red light onto the subject, the AF illuminator, which has a range of 1 to 9 meters (with 50mm lens, based on Minolta's standard test method), provides the contrast needed for autofocus operation.

The AF illuminator does not operate when the lens focal length is equal to or greater than 210mm.



The focus signal displayed in the viewfinder when you press the shutter-release button down depends on whether the subject is still or moving, and on whether or not the camera is able to find focus. When you operate the camera in AF mode, the shutter remains locked if focus cannot be confirmed. Known as focus-priority operation, this design reduces the possibility of your taking an out-of-focus picture.

	Still	Moving
For Confirmed	 (green)	 (green)
Focus Not Confirmed	 (red)	 (green)

For low-contrast subjects beyond the AF illuminator's range, the camera may be unable to confirm focus (Fig. A); in these cases, use focus hold (p.26) or focus manually (p.29). The focus-not-confirmed signal for a moving subject will be displayed if its speed is too fast for auto-focusing. Refer to p.28 for more information on subjects difficult to autofocus.

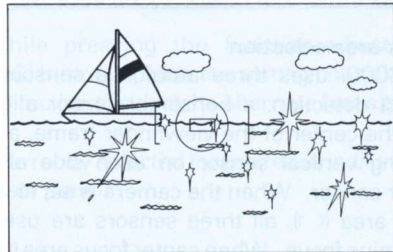

A

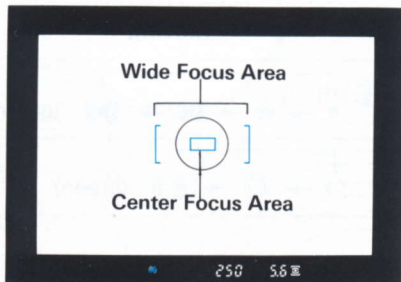

Focus-area selection

The 8000i uses three autofocus sensors for subject detection: a horizontal sensor aligned with the center of the viewfinder frame, and a flanking vertical sensor on each side of the center sensor. When the camera is set to wide focus area (☐), all three sensors are used to determine focus. When center focus area (○) is selected, only the center sensor is used.

Wide Focus Area

Wide focus area is set automatically by the camera when you press the program-reset button. It is convenient for general photographic situations, and especially useful for autofocusing on fast-moving subjects. Even if the main subject is not in the exact center of the frame, the camera will focus correctly.

Center Focus Area

If the camera is set to wide focus area, it may be difficult to focus on one person standing in a crowd, since more than one subject will fill the focus area. By selecting center focus area, you can limit autofocus sensitivity to the small area marked in the center of the viewfinder. Center focus area is also useful for taking closeup photographs.

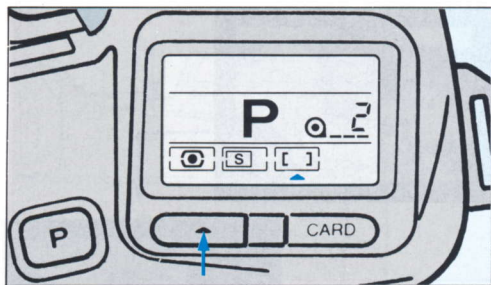

To select the focus area:

1. Press the function-selector key so that the data panel's function pointer is beneath the focus area indicator.

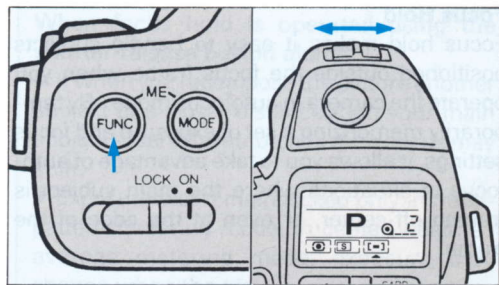

2. While pressing the function-adjustment (**FUNC**) button in, slide the setting control in either direction to select the alternate focus area.

The currently selected focus area is indicated in the data panel.

Focus Hold

Focus hold makes it easy to handle subjects positioned outside the focus frame when you operate the camera in autofocus mode. By temporarily memorizing a set of exposure and focus settings, it allows you to take advantage of autofocus in situations where the main subject is framed off-center, or even at the edge of the frame.

Focus hold can be operated in two ways: with the shutter-release button alone, or by using the shutter-release button in combination with the focus-hold button. The main difference between the two is duration. Using the shutter-release button alone, focus is held for a single exposure only; with the focus-hold button, the AF system is actually disengaged (**M. FOCUS** will be displayed in the data panel) and the current focus setting will be held as long as the focus-hold button is pressed in.



To use focus hold, first center the focus frame on your subject, then press the shutter-release button partway down so that the green focus signal glows. For operation with the shutter-release button alone, simply recompose the picture as desired, making sure that the green focus signal continues to glow, then press the shutter-release button all-the-way down to take the picture.

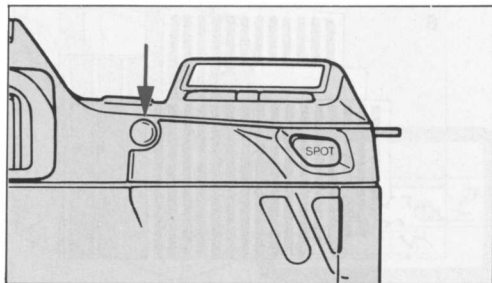

For operation with the focus-hold button, follow the same procedure, except press and hold the focus-hold button before recomposing the picture. The focus set in the first step will be locked as long as the focus hold button is pressed, even if you let go of the shutter-release button.

When focus hold is operated using the shutter-release button alone:

- If when you recompose the picture another subject at a closer distance than your main subject enters the autofocus zone, focus may shift.
- Exposure will remain locked only in multi-pattern metering mode; in center-weighted average metering mode, exposure may change when the picture is recomposed.

Using the Customized Function Card, available separately, the focus-hold button's function can be changed so that it selects continuous autofocus or center-area focus. Refer to the card's manual for more information.



Special Focusing Situations

The camera's autofocus system will produce sharp pictures in nearly any situation. In those cases where focus is not correctly set, however, manual focus is recommended.

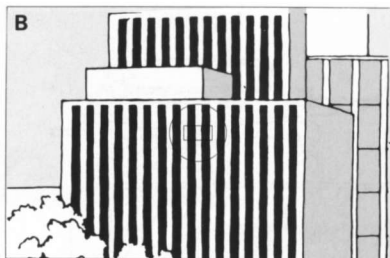

- If two subjects are at different distances within the focus frame, focus manually (A).
- If a subject composed of alternating light and dark lines fills the focus frame, focus manually (B).

MANUAL FOCUS

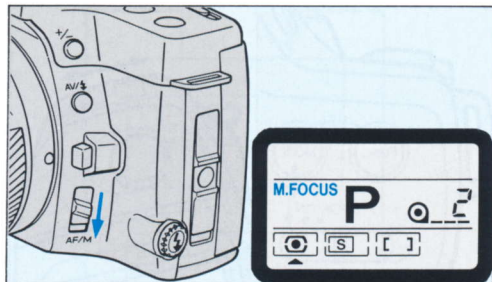

The lens can be focused manually by turning the lens focusing ring, and checking for sharpness on the focusing screen;

To use manual focus:

1. Switch the camera on, then slide the focus-mode switch downwards so that **M.FOCUS** is displayed in the data panel. (The focus-mode switch will return to its rest position when released, but manual focus mode will remain set; to restore autofocus mode, slide the focus-mode switch down again.)

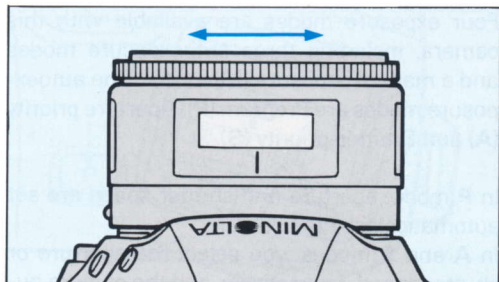

2. Turn the focusing ring until the subject appears sharp on the focusing screen.
3. Press the shutter-release button all-the-way down to take picture. (When using manual focus, focus-priority operation is not in effect: The shutter can be released at any time, even if the subject is not in focus.)

When focusing manually, you can activate the viewfinder focus signals by maintaining light pressure on the shutter-release button. If conditions are sufficient for subject detection by the autofocus sensors, the green focus signal will glow when the subject comes into focus; otherwise, the red focus signal will blink.

4. EXPOSURE

BASIC INFORMATION AND MODE SELECTION

Four exposure modes are available with this camera, including three autoexposure modes and a manual exposure (**M**) mode. The autoexposure modes are Program (**P**), Aperture priority (**A**) and Shutter-priority (**S**).

In **P** mode, aperture and shutter speed are set automatically by the camera.

In **A** and **S** modes, you select the aperture or shutter speed, respectively, and the camera automatically makes the other setting to obtain correct exposure. In **M** exposure mode, you directly control both the shutter speed and aperture settings, and thus overall exposure. In a wide variety of lighting situations, **P** mode provides precisely metered, correctly exposed images; in other situations, you may want to exercise more direct control over exposure, and for this purpose **A**, **S**, and **M** modes are suitable.

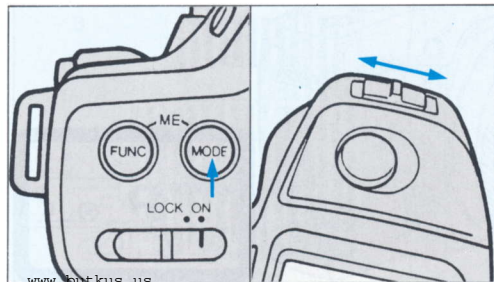

To select the exposure mode:

1. Press the **MODE** button.
2. Keeping the **MODE** button pressed in, move the setting control in either direction until the letter for the exposure mode you want to use appears on the data panel.

When you slide the setting control, the exposure mode changes in the order shown at right.

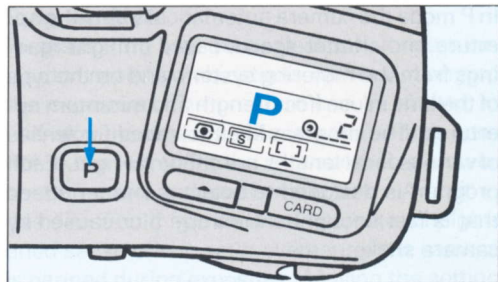
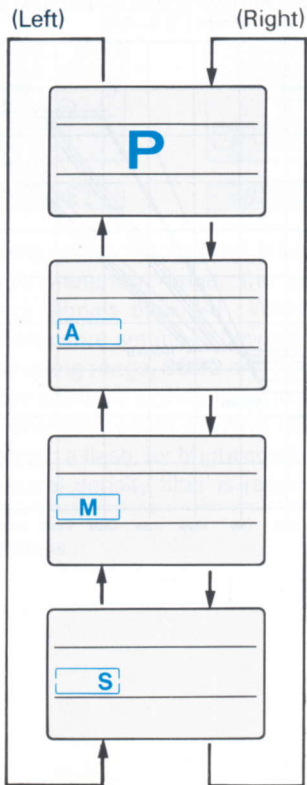

P mode can also be selected by pressing the program-reset button; since doing so also resets other camera functions to their standard positions, however, the procedure described on p.30 should be used if you wish to keep previously selected alternate settings of other camera functions.

P: PROGRAM MODE

In P mode the camera automatically sets the aperture and shutter speed, based on light readings from the metering system, and on the type of the lens in use (focal length and minimum aperture). The program lines followed for lenses of various focal lengths are shown at right. Each program is designed to select a shutter speed that is fast enough to minimize blur caused by camera shake.

Operating the camera in P mode leaves you free to concentrate on composition and other picture elements. When the shutter-release button is pressed partway down, the camera measures the ambient light, automatically determines correct exposure, and displays its program setting in the data panel. Shutter speed and aperture settings are made steplessly, and displayed to the nearest half-stop setting.

ADVANCED AUTOMATIC MULTI-PROGRAM SELECTION
(WITH AF 35—105mm f/3.5—4.5)

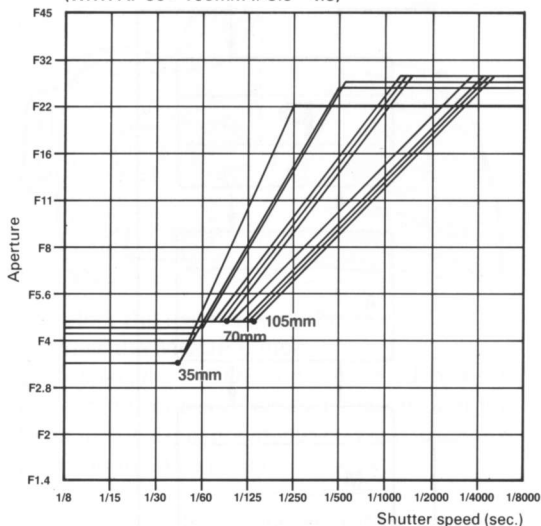

A

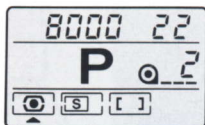

B

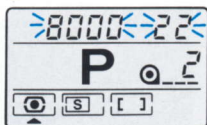

When the ambient light level is beyond the camera's metering range, the viewfinder exposure signals blink (A). When the required exposure setting is beyond the camera's coupling range, **8000** and the smallest available aperture setting blink in the viewfinder and data panel displays (B). In low light, attach a flash; for bright conditions, use of a neutral density filter is recommended.

Program Shift

Program shift lets you select other aperture-shutter speed combinations without changing the exposure. The program can be shifted in half-stop increments. Moving the setting control to the left shifts the exposures to a slower shutter speed and smaller aperture. A shift in this direction might be used to create a heightened sense of subject movement if the camera is panned during exposure. Moving the setting control to the right shifts the exposure towards a faster shutter speed and a wider aperture.

- Shifted settings are held for five seconds after you lift your finger from the shutter-release button. To take several pictures using program shift, maintain light pressure on the shutter-release button.
- When using zoom lenses, shift the program after zooming; otherwise, the shifted setting will also change.

Program Shift

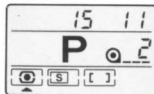
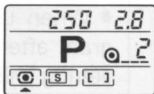
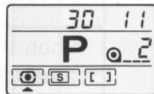
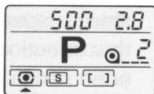

A: APERTURE-PRIORITY MODE

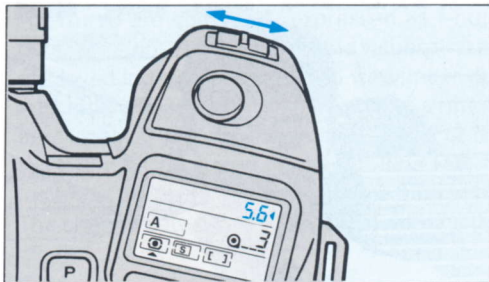

In A mode you can set the aperture to control depth of field and the camera will automatically set the shutter speed required for correct exposure at that aperture setting.

To set the aperture: With the camera set to A mode, use the setting control to select the aperture. Moving the control to the right sets a smaller aperture number, and to the left sets a larger aperture number. The aperture setting changes in half-stop increments each time you move the setting control; holding the setting control in either direction causes the aperture value to change continuously.

You can set any available aperture within the aperture range indicated on the AF lens you are using. For example, the AF 50mm/1.7 lens is marked 1:1.7 (22), indicating an aperture range of f/1.7 to f/22.

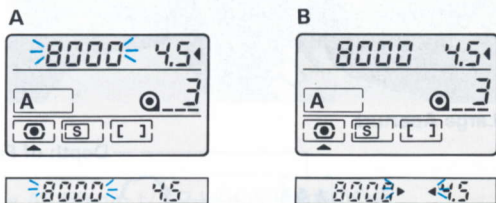

- If the shutter speed required for correct exposure at the aperture setting you have selected is not available, the data panel's shutter speed display blinks (A). If **8000** blinks, close down the aperture until the blinking stops; if **30** blinks, open up the aperture until the blinking stops. If both viewfinder exposure signals blink, the ambient light level is beyond the camera's metering range (B).



Large Aperture



Small Aperture

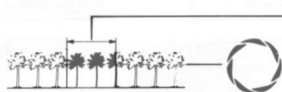

Depth of Field



The size of the lens aperture through which light from the subject enters the camera is an important factor in determining depth of field, or the distance range behind and in front of the subject that will be in focus. A mode allows you to vary the size of the aperture in order to control the depth of field in a particular way, without sacrificing the convenience of autoexposure.

As shown in the example photos above, the depth of field becomes greater as the size of the lens aperture decreases. A large aperture setting might be useful if you want to separate a subject from its surroundings, while a small aperture would be preferred when you want the focus range to extend as far as possible, as in a landscape picture.

Apertures are commonly expressed as f-numbers, or f-stops, and these are the values that are displayed in the data panel and viewfinder during camera operation. An f-number is a ratio of lens focal length to aperture diameter. For this reason, with a given focal length lens $f/8$, for instance, indicates a larger aperture than $f/11$. The change between two aperture settings that

results in either a doubling or halving of the amount of light reaching the film is referred to as a one-stop difference. Listed below are the available apertures when you use the AF 50mm $f/1.7$ lens. Since successive values represent half-stop changes, it would be necessary to move two positions— for instance, from $f/16$ to $f/11$ — to change the exposure by one stop.

Available apertures, in **A** and **M** modes, using the AF 50mm $f/1.7$ lens

1.7	2	2.4	2.8	3.5	4	4.5	5.6	6.7	8	9.5	11	13	16	19	22
-----	---	-----	-----	-----	---	-----	-----	-----	---	-----	----	----	----	----	----

S: SHUTTER-PRIORITY MODE

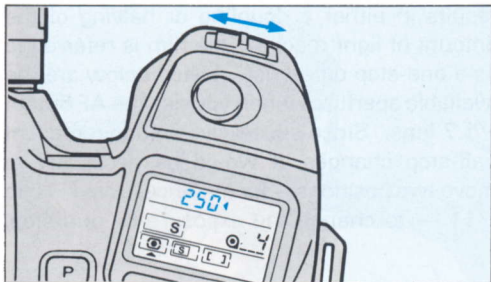

S mode is most useful for taking pictures of moving subjects. You can use fast shutter speeds, up to 1/8000 of a second, to freeze the action, or slower speeds to intentionally blur subject movement. The camera automatically sets the aperture required for correct exposure at the shutter speed you've selected, and displays it to the nearest half-stop.

To set the shutter speed: With S mode set, move the setting control to the left to set a slower speed, and to the right for a faster speed. Each time you move the setting control, the shutter speed changes by one stop; holding the setting control in either position causes the shutter speed to change continuously.

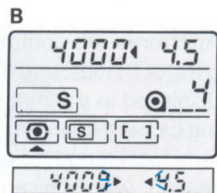
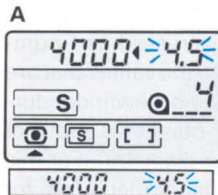

- If the lens' minimum aperture setting blinks in the data panel, set a faster shutter speed until the blinking stops; if the lens' largest aperture setting blinks, reduce the shutter speed until the blinking stops (A).
- If both viewfinder exposure signals blink, the light level is beyond the camera's metering range (B). In low light, use a Program flash unit (see page 56)
- Although the **bulb** setting can be selected in S mode, it cannot be used. Long exposures can only be taken in Manual exposure mode. Refer to the following section for more information.



Slow Shutter Speed

Your choice of shutter speed is an important factor in determining how moving subjects will be recorded. Slow shutter speeds, such as $1/30$ or $1/15$ of a second, will make moving subjects appear to flow.



Fast Shutter Speed

Fast shutter speeds, such as $1/500$ or $1/1000$ of a second, can be used to freeze the action of a moving subject. When using telephoto lenses, a fast shutter speed should be used to prevent image blur caused by camera shake.

Listed below are the selectable shutter-speed settings in **M** and **S** modes.

$1/8000$ $1/4000$ $1/2000$ $1/1000$ $1/500$ $1/250$ $1/125$ $1/60$ $1/30$ $1/15$ $1/8$
 $1/4$ $1/2$ $1''$ $2''$ $4''$ $8''$ $15''$ $30''$ (bulb) (**Bulb** setting should only be used in **M** mode)

Using the Customized Function Card, operation can be modified so that shutter speeds are selectable in half-stop settings.

M: MANUAL EXPOSURE MODE

Manual mode can be used when you want full creative control of exposure. In this mode, you can set the aperture to control depth of field, and the shutter speed to control the expression of subject movement. Viewfinder exposure signals make it easy to set the camera for correct exposure. If desired, you can also vary the exposure based on your own experience.

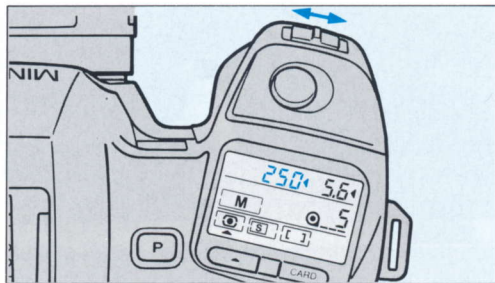

To set the shutter speed: Move the setting control to the right to set a faster shutter speed, and to the left to set a slower shutter speed; the shutter speed changes in full-stop increments.

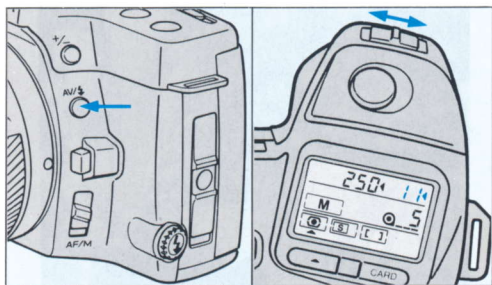

To set the aperture: While holding in the aperture-setting button, move the setting control to the left to set a larger aperture number (smaller aperture opening) and to the right to set a smaller aperture number (larger aperture opening); the aperture changes in half-stop increments.

In M mode, the viewfinder exposure signals appear when the shutter-release button is pressed partway down, allowing you to compare the current exposure with that which would be made by the camera in an autoexposure mode. The metering signals that appear during M mode operation are as follows:

	Exposure correctly set
	Slide setting control to the right
	Slide setting control to the left
	Light level beyond metering range, correct exposure cannot be determined

The - and + symbols indicate whether the picture will be underexposed or overexposed, respectively, at the current exposure settings.

5. METERING

BASIC INFORMATION

The camera determines exposure by evaluating light reflected into the lens from your subject, a system known as through-the-lens (TTL) metering. By selecting the way in which the reflected light is evaluated, you can tailor the camera's metering system to suit either a particular shooting situation, or a personal preference. The camera's three metering modes, and their indicator displays in the viewfinder and data panel, are:

Multi-pattern: 

Center-weighted average: 

Spot: 



Multi-pattern metering is the camera's standard metering mode, and gives correct exposure in a wide variety of situations. In this mode, the image area is divided into six segments from which separate meter readings are taken. Unlike spot or center-weighted average metering, multi-pattern metering integrates subject position data from the autofocus system; based on autofocus data, light readings from the different cell segments are combined to generate an exposure setting tailored to the subject. For general picture-taking situations, multi-pattern metering should give excellent results.



Center-weighted average metering evaluates the light level of the overall image area, independent of the autofocus system. The sensitivity of the metering pattern is graded so that the center of the image area, where the main subject is usually found, influences the exposure setting more strongly than do the outer areas of the image.

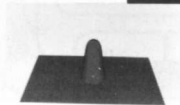

In Spot metering mode the metering system restricts its measurement to the circular area marked in the center of the viewfinder frame, about 2.3% of the actual image area. If you're shooting a high-contrast subject, spot metering can be used to selectively meter a mid-tone area.

MODE SELECTION

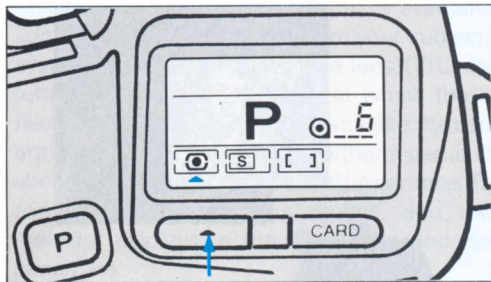

Multi-pattern and Center-weighted-average metering

To select multi-pattern or center-weighted average metering:

1. Press the function selector key so that the function pointer is beneath the metering-mode indicator.

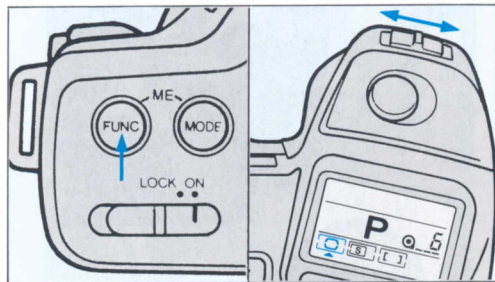

2. While holding in the function-adjustment button, slide the setting control in either direction so that the indicator for the appropriate metering mode is displayed.

Multi-pattern metering can also be selected by pressing the Program Reset button; since doing so also resets other camera functions to their standard positions, however, the procedure described above should be used if you wish to keep previously selected alternate settings of other camera functions.

Spot Metering

Unlike multi-pattern or center-weighted average metering, spot-metering is selected on a temporary basis only. Activated by holding down the **SPOT** button, spot metering overrides the current metering mode, and its measured exposure is retained as long as the **SPOT** button is held in; once the **SPOT** button is released, the previously active metering mode is restored.

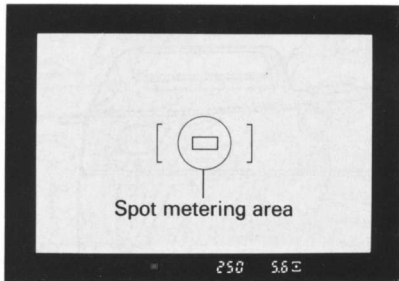

To use spot metering:

1. Focus on the subject.
2. Aim the camera so that a mid-tone area fills the spot-metering area, then press in the **SPOT** button.

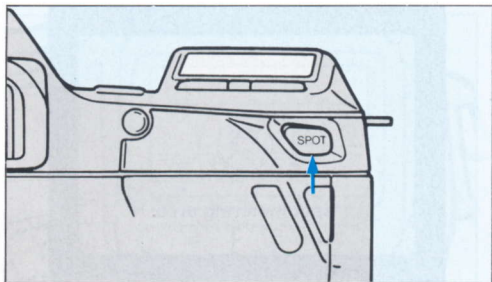

3. Keeping the **SPOT** button pressed in, re-compose the frame as needed and release the shutter.

In autoexposure modes, the spot button must be kept pressed until the shutter is released; in manual exposure mode, the spot button need only be held to obtain the exposure readout, either through the viewfinder or data panel display. While the **SPOT** button is pressed in,  is displayed at the bottom of the viewfinder.

With a Minolta i-series Program flash in use and the camera set to either **P** mode or **A** mode, you can use the spot button to program a slower shutter speed (In this case, spot metering does not function). Refer to the flash's instruction manual for more information about slow-shutter sync.

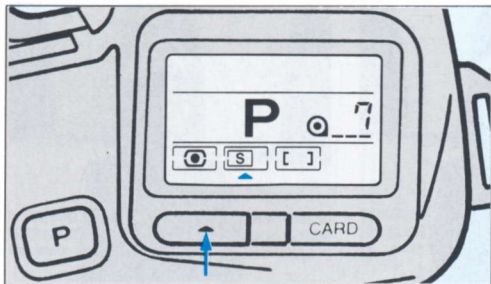

This camera gives you a choice of two film-advance modes. In single-frame mode (S), the film is advanced one frame each time you release the shutter. In continuous mode (C), successive exposures are made and the film is advanced continuously, at up to 3 frames per second, while the shutter-release button is held down. When you operate the camera in continuous mode, with autofocus set, the focus setting is adjusted between exposures to ensure sharp pictures.

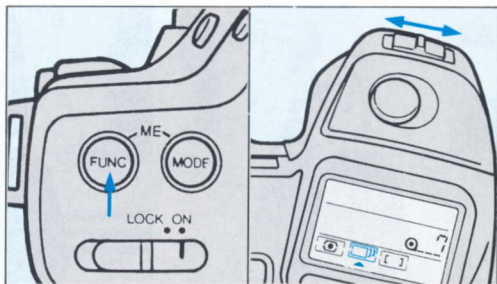

To select the film-advance mode:

1. Press the function-selector key to move the function pointer under the film-advance mode indicator in the data panel.
2. Hold down the function-adjustment (**FUNC**) button and slide the setting control in either direction to change the film-advance mode.

7. EXPOSURE OPTIONS

EXPOSURE ADJUSTMENT



The exposure-adjustment function offers a quick way to selectively bias exposure. It is useful for subjects that, based on experience, you think should be over- or underexposed, compared with exposure at the nominal ISO setting, or for making several different exposures of a

scene (exposure bracketing) to make sure that one of them is exposed precisely the way you want. Easily operated, and with a corresponding viewfinder display, exposure adjustment is designed so that you can use it without removing your eye from the viewfinder.

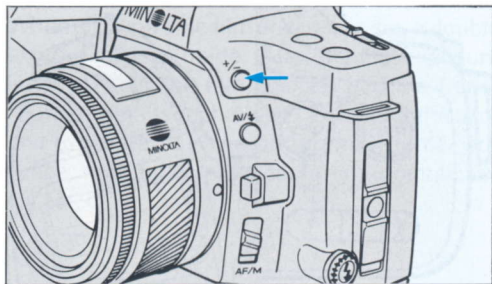

To set an exposure adjustment:

1. Press in the exposure-adjustment button.
2. While keeping the button held in, move the setting control to the right for increased exposure adjustments, and to the left for decreased exposure adjustments. The adjustment range is ± 4 stops, and is set in half-stop increments.

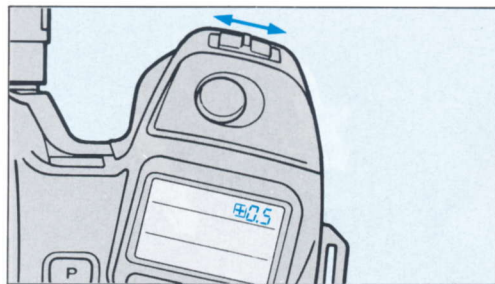

Whenever an exposure adjustment is set, the - or + signal will appear in viewfinder and data panel. The actual adjustment can be confirmed at any time by pressing the exposure adjustment button.

Remember to reset the exposure adjustment to ± 0.0 when you're through using it; otherwise, subsequent exposures will be over- or underexposed.

MULTIPLE EXPOSURE

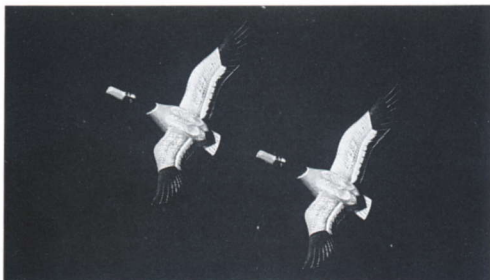

The 8000i's multiple-exposure function enables you to expose a single frame two or more times. Used skillfully, it is a technique that can lead to unusual and pleasing images.

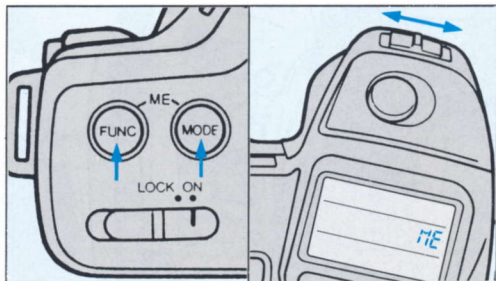

To set multiple-exposure operation:

While holding in the **FUNC** and **MODE** buttons, slide the setting control in either direction. **ME** will appear in the data panel to indicate that the camera is set for multiple exposure operation.

If you change your mind after setting the camera for a multiple exposure, it can be easily canceled by repeating the setting procedure.

When single-frame film advance is set, a double exposure can be made. After the first exposure is taken, both the film position and the frame counter remain unchanged. Following the second exposure, the film and frame counter advance, and multiple exposure is automatically canceled.

When single-frame advance is set, multiple exposure can be canceled after the initial exposure is made by repeating the setting procedure (i.e., sliding the setting control while pressing in both the **FUNC** and **MODE** buttons).

If the Data Memory Card is in use, the last exposure of a multi-exposure sequence will be retained in memory.

If continuous film advance is used with multiple exposure, a single frame will be exposed repeatedly as long as the shutter-release button is held down. Once you let go of the shutter-release button, the film and frame counter advance, and multiple exposure will be automatically canceled.

- When the camera is set for autoexposure operation, each step in a multi-exposure sequence is exposed as if it were the only exposure on the frame. In cases where the background is dark and the subject doesn't overlap in successive steps, exposure should be correct. In other cases, exposure compensation may be required. For double exposures, each exposure should be reduced by one stop; for other multi-exposures you may need to experiment to determine the correct exposure compensation.
- For multiple exposures, avoid using the first or last several frames on a roll of film; the degree of film curl occurring on those portions of the roll may adversely affect image registration.

SELF-TIMER

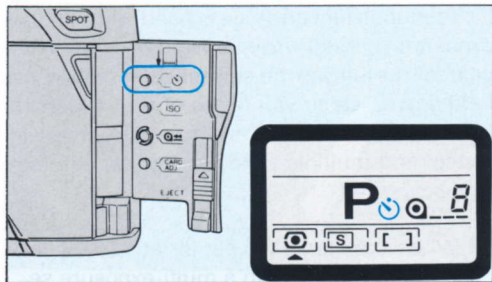

The self-timer allows you to set a ten-second shutter-release delay.

To operate the self-timer:

1. Open the card door and press the self-timer (⌚) button. The self-timer indicator (⌚) will appear in the data panel.

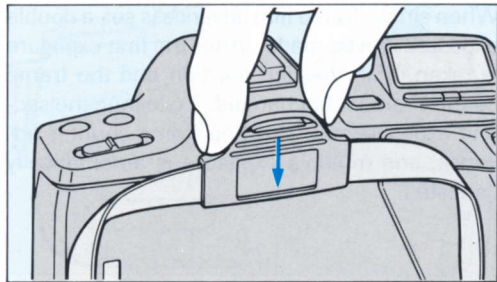

2. Focus the lens and attach the eyepiece cap.
3. Press the shutter-release button all-the-way down to start the self-timer. During countdown the self-timer light and the data panel's self-timer indicator blink twice a second.

Before starting the self-timer, confirm that focus is correctly set by checking for the green focus signal; autofocus does not function once the self-timer is started. To take another picture using the self-timer, repeat steps 1-3.

Following step 1, the self-timer can be canceled by pressing the self-timer button a second time. Once started, it can be reset by moving the main switch to **LOCK**; when the camera is next switched on, self-timer mode will be set and self-timer operation can be started by pressing the shutter-release button.



LONG EXPOSURES

The **bulb** shutter-speed position can be used for making exposures of longer than 30 seconds duration. Long exposures are appropriate for photographing a variety of subjects, including fireworks, lightning storms, city skylines after sunset, etc.

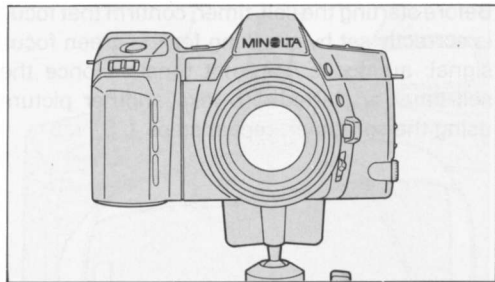

To make a long exposure:

1. Mount the camera on a tripod. Be careful not to overtighten the the tripod's mounting screw, and not to use a screw longer than 5.4mm (1/4 in.).

For extended exposures using the **bulb** setting, installation of a fresh battery is recommended.

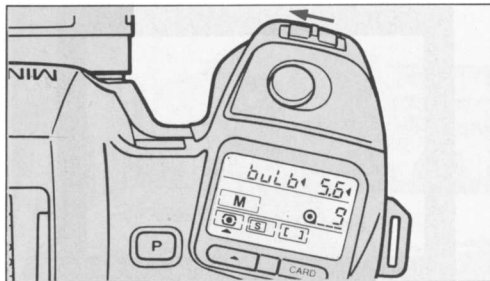

2. Set the camera to **M** exposure mode, then slide the setting control to the left until **bulb** appears in the data panel.
3. Set the aperture.
4. Focus the lens, and then attach the eyepiece.
5. Release the shutter. (At **bulb**, the shutter remains open as long as the shutter-release button is held down.)

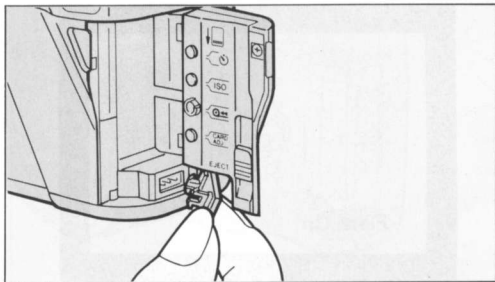

For making long exposures, use of a remote cord, either RC-1000S or RC-1000L, is strongly recommended to minimize camera shake. Both cords have locking shutter-release buttons, convenient for keeping the shutter open for extended periods. To attach a remote cord, remove the remote control terminal cover and insert the remote cord plug.

FLASH PHOTOGRAPHY

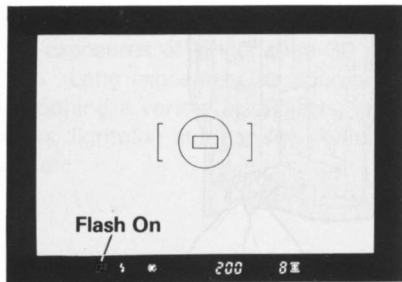

Your Dynax 8000i uses an advanced flash control system for correct flash exposures anytime—in daylight, low light, or total darkness. In all exposure modes, the camera's TTL (through-the-lens) flash metering system controls the flash output to ensure proper exposure.

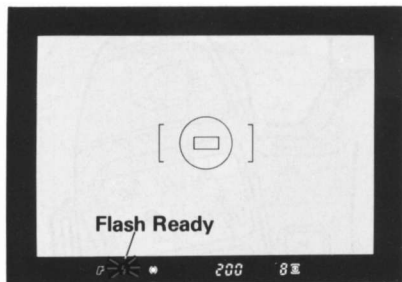

When using a dedicated flash, two flash signals appear in the viewfinder. The flash-on signal appears whenever the flash unit will fire when charged. In P mode, the camera automatically activates and fires the flash when the light level is very low or if fill flash is required. A special fill-flash program lightens shadows without washing out highlight details, and controls the background exposure in brighter conditions. The flash-ready signal blinks slowly when the flash is charged, and then rapidly, following exposure to confirm sufficient exposure.



With Fill Flash



Without Fill Flash

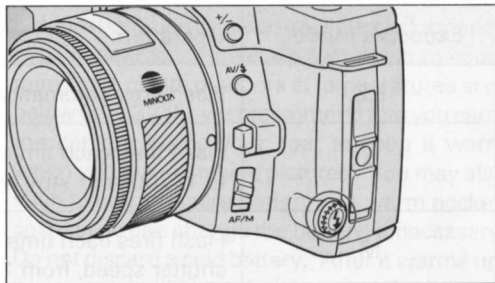

The camera's sync terminal accepts PC-type sync cords from flash units that do not have a hot-shoe contact. Note that with such units, TTL-flash metering does not operate; use manual exposure mode and set the shutter speed to 1/125 sec. or slower. Refer to the flash's instruction manual to determine the aperture required for correct exposure, or use a flash meter.

Using the Customized Function Card enables you to set the shutter speed as high as 1/180 sec. in manual-exposure-mode flash applications.

Flash Operation with i-series Flashes

Exposure Mode	Operation
P,S	Flash fires automatically when required*
A	Flash fires each time the shutter is released, and X-sync speed is set to 1/200 sec. Any aperture can be set.
M	Flash fires each time the shutter is released. Any aperture, and any shutter speed, from 1/200 to 30 sec. can be selected.

* With an i-series flash attached and switched on, pressing the aperture-setting button causes the flash to fire each time the shutter is released.

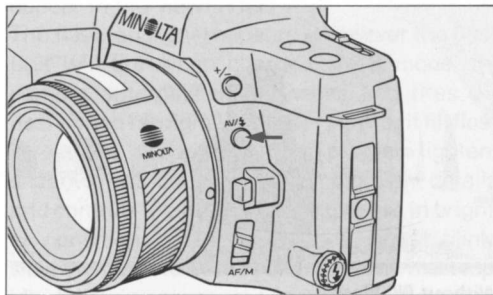

MAIN SWITCH

When the main switch is at **ON**, all camera functions operate and you can take pictures. At **LOCK** position, main camera functions are switched off, and the shutter will not release. When not using the camera, set the main switch to **LOCK** to prevent accidental exposures and ensure optimum battery life. When film is loaded, the current frame number remains displayed in the data panel when the main switch is set to **LOCK**.

When you switch the camera on, with a Minolta AF lens attached, the camera's autofocus system adjusts the lens extension in preparation for autofocus operation. Similarly, when the camera is switched to **LOCK**, the autofocus system automatically retracts the lens to its shortest extension for ease of carrying or storage.

COLD-WEATHER OPERATION

Lithium batteries provide excellent performance in cold weather. However, if you plan to shoot many rolls of film outdoors at temperatures at or below 0°C (32°F), we recommend that you carry the camera inside your coat to keep it warm when you are not taking pictures. You may also wish to carry a spare battery in a warm pocket, so that you can change the battery, if necessary. Do not discard a cold battery. After it warms up, its capacity will be restored.

BATTERY PERFORMANCE

The 6-volt 2CR5 lithium battery should provide sufficient power for shooting up to 50 rolls of 24-exposure film. These figures are based on Minolta's standard test method using a fresh battery at 20°C (68°F). Actual battery performance will depend on how you use the camera. Also if you install a freshly purchased battery that has been in prolonged storage, battery performance may vary.

ATTACHING THE NECKSTRAP AND EYEPIECE CAP

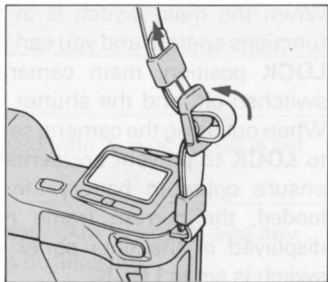
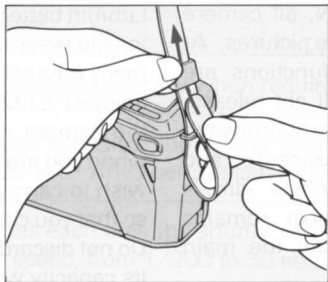
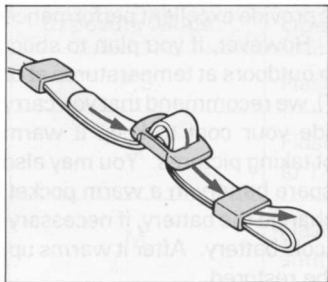

A neckstrap is supplied with your Dynax 8000i for easy carrying. Attach it to the camera as shown above. An eyepiece cap is also supplied

and can be slipped onto the neckstrap to keep it handy for use.

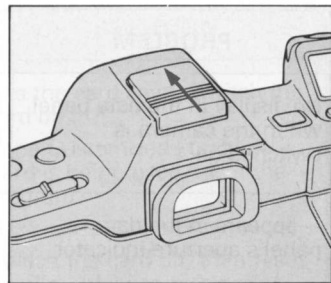
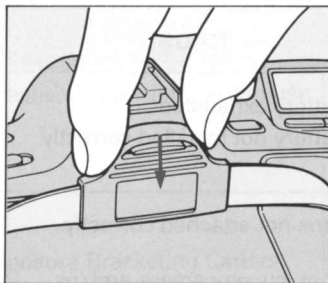
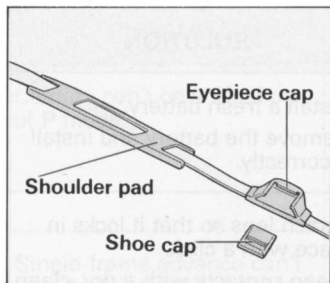

The eyepiece cap slides over the eyepiece to prevent stray light from entering the camera and affecting exposure. It should be used whenever the eyepiece is not shielded by your head, as when using the self-timer or when operating the camera by remote control. To attach the eyepiece cap, first remove the eyepiece cup, then slip the cap over the frame.

An accessory shoe cap is supplied that slips into the accessory shoe to protect the contacts from dust and grime. When using a flash unit, slip the accessory shoe cap into the eyepiece cap.

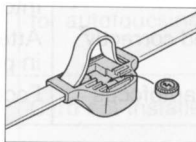

When using the sync terminal, the sync cap can also be stored in the eyepiece cap, as shown.

9. TROUBLESHOOTING

PROBLEM	CAUSE	SOLUTION
No display in the data panel when the camera is switched on	Battery exhausted Battery not installed correctly	Install a fresh battery. Remove the battery and install it correctly.
-- appears in the data panel's aperture indicator	Lens not attached correctly Contacts on camera and/or lens are dirty	Attach lens so that it locks in place with a click. Clean contacts with a dry, clean cloth.
HELP displayed in the data panel	Winding motor problem	Remove the battery, then reinstall it.
Autofocus does not work or the lens does not focus when the shutter-release button is pressed	Camera set to manual focus Lens' zooming grip is positioned in the macro range Lens is not attached correctly Subject difficult to autofocus	Set the camera to autofocus mode. Move the zooming grip back into the zoom range. Attach the lens so that it locks in place with a click. Focus manually.

PROBLEM	CAUSE	SOLUTION
Camera can't be shifted out of P mode	Creative Expansion Card in use	Use the card key to switch the card off. If the Customized Function Card is being used, reset the program.
Single-frame advance can't be selected	Exposure Bracketing Card or Automatic Program Shift Card in use	Switch the card off, then reset the film-advance mode
Flash doesn't fire or  signal doesn't appear	Flash's power switch at OFF position Flash not attached correctly	Switch the flash ON . Attach the unit so that it locks in place with a click.
Focus is not adjusted when using flash	Distance to subject is too close or too far Subject's reflectivity is too low for autofocusing	Check that the subject is within the flash range. Focus on another subject at the same distance away as the main subject.
Card system does not function	Card not installed correctly	Install the card correctly.

ACCESSORIES



Creative Expansion Cards

The Creative Expansion Card system provides a unique way to expand the 8000i's capabilities to meet specific needs.

Although illustrations in the manuals for some of the cards show a different camera body, card operation with the 8000i is correct as described.



Multiple Exposure Card — Designed exclusively for the Dynax 8000i, this card allows you to make up to nine exposures on the same frame.

Besides its standard mode, in which each exposure in the sequence is made at the "normal" exposure value, the card offers "Fade-in" and "Fade-out" modes that produce a series of graded exposure changes from the normal value.



Flash Bracketing Card — Allows you to shoot a series of flash exposures with a preset exposure change in each frame. Three, five, or seven exposures can be set, with changes in exposure of 0.5 or 1 EV steps.



Multi Spot Memory Card — Allows you to store exposure values for up to eight spots areas within a scene, and then expose the scene based on the average of these multiple readings.



Highlight/Shadow Control Card — Enables you to reproduce highlight and shadow tones more naturally. Used with the camera's spot metering system, it automatically increases exposure 2.3 stops for highlights and decreases exposure 2.7 stops for shadows.



Exposure Bracketing Card — This card allows you to program the 8000i to make a series of exposures with a selectable exposure adjustment between exposures. Three, five, or seven exposures can be programmed and an exposure change of 0.3, 0.5, or 1 stop can be selected.



Automatic Program Shift Card — This card programs a three-frame exposure series in which the overall exposure remains the same but the aperture/shutter speed combination varies; it lets you record a given scene three different ways. The size of the program shift can be set to one, two, or three stops.



Fantasy Effect Card — Causes the camera to automatically shift the focus during exposure to provide a mixture of two different creative effects. One is a soft-focus effect which softens edges and details for a misty, dreamlike effect. The other is a zoom-like effect which adds impact to your pictures.

Data Memory Card — Lets you store a variety of exposure data for up to 40 exposures on a given roll of film. Exposure mode, shutter speed, aperture, exposure adjustment, lens focal length, and maximum lens aperture data can be stored and then recalled when you want to check exposure settings.



Sports Action Card — Controls the camera's basic settings for taking pictures of fast-moving subjects. The autoexposure program is automatically shifted according to subject distance and lens focal length in use.



Portrait Card — Uses a special exposure program to provide depth of field suitable for portraits. This program automatically adjusts aperture and shutter speed so that your subject is separated from the background.



Automatic Depth Control Card — This card automatically controls the camera's aperture setting to maximize depth of field so that both foreground and background subjects will be in sharp focus.



Closeup Card — Sets a special exposure program that provides depth of field suitable for close-up and macro shots. It sets the aperture based on subject magnification, and selects the shutter speed to provide correct exposure at that aperture.

Customized Function Card — This card lets you tailor several of the camera's standard features to suit personal tastes. Among the features that may be modified are:

Frame number: increasing or decreasing

Film rewind: automatic or manual start

Film leader: rewound into cartridge or left out

Focus hold button: focus hold, center area focusing or continuous focus adjustment



Minolta AF Lenses

The entire system of Minolta AF lenses is usable with your Dynax 8000i camera. Besides a wide range of zoom and fixed focal length lenses, special application optics such as the AF Reflex 500mm, and the recently introduced AF Macro Zoom 3X-1X are also available. Visit your Minolta dealer for more information about Minolta AF lenses and accessories.



Minolta AF Lenses Basic Specifications

Lens	Elements/ Groups	Angle of View	Minimum Focus	Minimum Aperture	Filter (dia.)	Dimensions (dia. x length)	Weight
AF 16/2.8 Fisheye	11/8	180°	0.2m	f/22	integral	75 x 66.5mm	400g
AF 20/2.8	10/9	94°	0.25m	f/22	72mm	77.5 x 63.5mm	285g
AF 24/2.8	8/8	84°	0.25m	f/22	55mm	65.5 x 44mm	210g
AF 28/2	9/9	75°	0.3m	f/22	55mm	66.5 x 49.5mm	285g
AF 28/2.8	5/5	75°	0.3m	f/22	49mm	65.5 x 42.5mm	185g
AF 35/1.4	10/8	63°	0.3m	f/22	55mm	65.5 x 76mm	470g
AF 35/2	7/6	63°	0.3m	f/22	55mm	66.5 x 48.5mm	240g
AF 50/1.4	7/6	47°	0.45m	f/22	49mm	65.5 x 38.5mm	235g
AF 50/1.7	6/5	47°	0.45m	f/22	49mm	65.5 x 39mm	170g
AF 85/1.4	7/6	28°30'	0.85m	f/22	72mm	78 x 71.5mm	550g
AF 100/2	7/6	24°	1.0m	f/32	55mm	67 x 75.5mm	480g
AF 135/2.8	7/5	18°	1.0m	f/32	55mm	65.5 x 83mm	365g
AF 200/2.8 Apo	8/7	12°30'	1.5m	f/32	72mm	86 x 134mm	790g
AF 300/2.8 Apo	11/9	8°10'	2.5m	f/32	integral	128 x 238.5mm	2480g
AF 600/4 Apo	10/9	4°10'	6.0m	f/32	integral	169 x 449mm	5500g
AF Reflex 500/8 ^{*1}	7/5	5°	4.0m	—	integral	89 x 118mm	665g

*1 Used with Dynax 8000i, 7000i or 5000i, can be operated in either autofocus or manual focus mode; with other Minolta AF SLR cameras (Dynax 3000i, 5000, 7000, 9000) manual focus only, by reference to the viewfinder screen, is possible.

Lens	Elements/ Groups	Angle of View	Minimum Focus	Minimum Aperture	Filter (dia.)	Dimensions (dia. x length)	Weight
AF 24-50/4	7/7	84°-47°	0.35m	f/22	55mm	69 x 60mm	285g
AF 28-85/3.5-4.5	13/10	75°-29°	0.8m	f/22-27	55mm	68.5 x 85.5mm	490g
AF 28-135/4-4.5	16/13	75°-18°	1.5m	f/22-27	72mm	75 x 109mm	750g
AF 35-80/4-5.6	8/8	63°-30°	0.5m	f/22-32	46mm	65 x 58mm	195g
AF 35-105/3.5-4.5	12/10	63°-23°	0.85m	f/22-27	55mm	68.5 x 59.5mm	290g
AF 70-210/3.5-4.5	12/12	34°-12°	1.1m	f/22-27	55mm	72.5 x 100mm	420g
AF 75-300/4.5-5.6	13/11	32°-8°10'	1.5m	f/32-38	55mm	72.5 x 163.5mm	865g
AF 80-200/2.8 Apo	16/13	30°-12°30'	1.8m	f/32	72mm	87.5 x 166.5mm	1350g
AF 80-200/4.5-5.6	9/9	30°-12°30'	1.5m	f/22-27	46mm	67 x 78mm	290g
AF 100-300/4.5-5.6	11/9	24°-8°10'	1.5m	f/32-38	55mm	72.5 x 100mm	410g
AF 50/2.8 Macro	7/6	47°	0.2m	f/32	55mm	68.5 x 59.5mm	310g
AF 100/2.8 Macro	8/8	24°	0.35m	f/32	55mm	71 x 98.5mm	520g
AF Macro Zoom ^{*2} 3X-1X/1.7-2.8	7/5	8x12mm (3X) ^{*3} 24x36mm (1X) ^{*3}	Working distance 25mm (3X) 40mm (1X)	f/16 (3X) f/27 (1X)	46mm	86 x 117 x 94.5mm ^{*4}	1100g
AF 1.4X Tele ^{*5} Converter II Apo	5/4	—	—	—	—	64 x 20mm	175g
AF 2X Tele ^{*5-6} Converter II Apo	6/5	—	—	—	—	64.5 x 43.5mm	210g

*2 Available spring 1990

*3 Size of subject that fills the film plane

*4 W x H x D

*5 For use with AF 200/2.8 Apo, AF 300/2.8 Apo, and AF 600/4 Apo lenses only; cannot be used with AF 80-200/2.8 Apo Zoom lens.

*6 When used with the AF 600/4 lens, autofocus cannot be used.

Accessory Flash Units

A number of accessory flash units are available for use with the 8000i.

Program Flashes 5200i, 3200i and 2000i

These units are designed specifically for use with Minolta i-system autofocus cameras, including the 8000i. They can be quickly and securely attached to the camera's accessory shoe.

Program Flash 5200i features a guide number of 52 (in meters), and offers such advanced features as auto power zoom from 24mm to 85mm, variable power level, ratio control for multiple flashes, and a multi-burst flash function.

Program Flash 3200i features a guide number of 32 (in meters), and automatically zooms to provide appropriate flash coverage for 28mm to 85mm lenses. The Program Flash 2000i, with a guide number of 20 (in meters), is a good choice for situations where less flash power is needed.

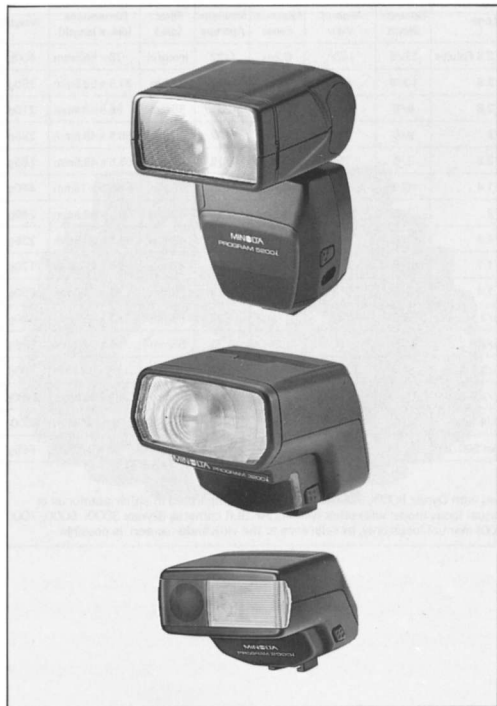



Macro Flash 1200AF Set-N

Macro Flash 1200AF Set-N is a specially designed unit that attaches to the 8000i via the Flash Shoe Adapter FS-1100. This unit has four flashtubes that can be controlled separately for versatile lighting control. Four focusing lamps provide illumination for focusing and TTL flash metering ensures accurate exposure at closeup and macro ranges. Used with the 8000i, this unit fires whenever the shutter is released, regardless of the exposure mode selected.

Other Flashes

The Flash Shoe Adapter FS-1100 must be used to attach the Program Flash 4000AF, 2800AF, or 1800AF to the Dynax 8000i. Used with the 8000i, these units fire whenever a picture is taken, regardless of the exposure mode selected.

The AF illuminators in the 4000AF, 2800AF and 1800AF do not operate when used with the Dynax 8000i. However, the camera's built-in AF illuminator provides for low-light autofocus. When using Program Flash 4000AF, the far limit of the flash range displayed on its data panel may be larger than the actual maximum distance. If your subject is close to the maximum distance, it may be underexposed. Sufficient exposure is confirmed by the glowing **OK EXP** signal; confirmation of sufficient exposure is also given by rapid blinking of the viewfinder's flash ready signal.

Accessory Backs

Data Back DB-7 permits imprinting of time and date information on the film, including year/month/day in three possible sequences, and day with 24 hour time, or time with indication for a.m. and p.m.. A single 3-volt lithium battery is installed at the factory and supplies power for data imprinting and for the automatic calendar and clock.

Program Back PB-7 can be used to imprint the date, day with 24-hour time, consecutive numbers or fixed numbers. An intervalometer function allows you to take pictures at preset intervals, and to make timed long exposures. For maximum versatility, the data imprinting, intervalometer, and long-exposure functions can be used together.



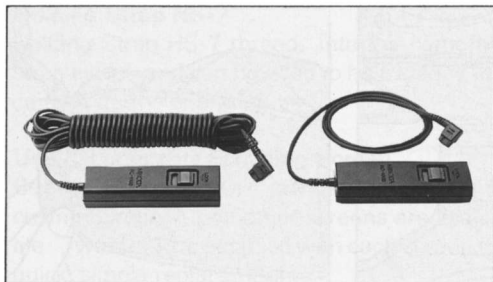

Remote Cord RC-1000L and RC-1000S

A remote cord should be used for taking long exposures (**bulb** setting), or anytime camera shake is likely to affect pictures. Autofocusing and metering are both activated by pressing the cord's release button. RC-1000L is 5m (16.5 ft.) long, and RC-1000S is 0.5m (20 in.) in length.



Wireless Controller IR-1N Set

The Wireless Controller IR-1N Set enables cordless, remote-control photography from up to 60 meters away. Single-frame and continuous film advance are both possible. Separate receivers can be used to control up to three cameras at the same time.

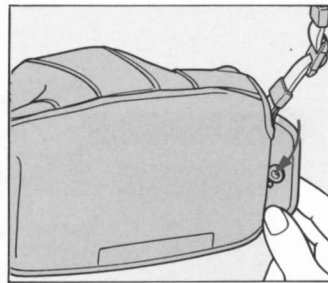
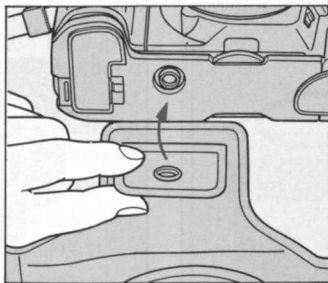
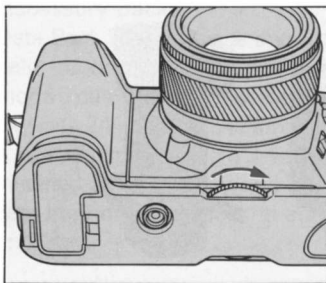

Case	Max. diameter of lens	Length of lens
CH-800	Less than 70mm	Less than 60mm
CH-800L	Less than 80mm	60mm ~ 100mm

Cases

Two camera cases are available as optional accessories for the Minolta Dynax 8000i. To put the camera in its case:

1. Attach the lens cap. (With the AF 35-80mm or AF 80-200mm, close the lens cover.)
2. If a zoom lens is attached to the camera, turn the zoom ring until the lens barrel is at its shortest position.
3. Follow the diagrams to put the camera in its case.

Holding Strap HS-7

Holding Strap HS-7 threads into the camera's strap eyelet, and can be used to help steady the camera during operation.

User-Changeable Focusing Screen

Besides Dynax 8000i's standard (Type G) Focusing Screen 7, two other screens are available. Tweezers are supplied with each screen for quick, simple replacement.

Type L screen has a grid pattern on a matte field. This screen is useful for general and architectural photography. Type S screen has vertical and horizontal scales on a matte field, and is useful for macro-, micro-, and astrophotography. Wide/center focus, and spot metering areas are marked on each screen.

Eyepiece Corrector 1000

Nine eyepiece-correction lenses are available for dioptic adjustment of the eyepiece. These lenses can be purchased separately and range from -4 to +3 diopters. The lenses snap into the camera's eyepiece frame.

Filters

Autofocusing can be done with these Minolta filters: L37 (UV), Y52 (yellow), GO (green), O56 (orange), R60 (red), 1B (skylight), A 12 (85), B 12 (80B), ND4X (two-stop neutral density), Minolta Portrayer filters, and Minolta Polarizing (Circular) filters.

Use of Other Filters

When using filters other than those listed here, the autofocus system may not function as desired. For best results, we recommend either that you focus manually with the filter attached, or attach the filter after autofocusing.

Minolta Polarizing (Circular) Filter

To reduce or eliminate reflections and glare from glass, water, or other non-metallic surfaces, Minolta's Polarizing (Circular) Filter should be used. If a regular polarizing filter is used, metering may not function properly.

APPENDIX

Operation Chart: Standard and Alternate Settings

Function	Standard Setting*	Alternates
Focus	AF	M
Focus Area	wide	center
Exposure	P	A,S,M
Exposure Adjustment	0	up to ± 4 stops**
Metering	multi-pattern	centerweighted, spot
Film Drive	single frame	continuous
Self-timer	off	on
Multiple Exposure	off	on

* Standard settings are selected when the program-reset button is pressed.

** Adjustable in 0.5 stop increments

Viewfinder and Data Panel Exposure Warnings

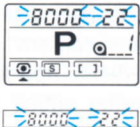
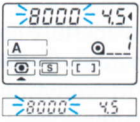
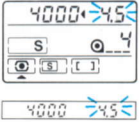
Data Display	Mode	Cause	Solution
	P,A, S,M	Light level beyond metering range	If the subject is too bright: use a neutral density filter
	P	Light level beyond coupling range	If the subject is too dark: increase the light level or use a flash
	A	Light level beyond coupling range	Open up or stop down the aperture so that the shutter speed display stops blinking.
	S	Light level beyond coupling range	Set a faster or slower shutter speed so that the aperture display stops blinking.

TECHNICAL DETAILS

Type: 35mm SLR with intelligent control of autofocus (AF), autoexposure(AE) and auto film transport systems

Lens Mount: Minolta A-type bayonet; accepts all Minolta AF lenses

Autofocus System: Minolta's through-the-lens (TTL) phase-detection type with wide charge-coupled device(CCD) sensor; sensitivity range: EV 0 to 18 at ISO 100 in ambient light; Predictive focus control; built-in AF illuminator automatically activated in low light, low contrast conditions; range: 1 to 9 meters, based on Minolta's standard test method using a 50mm f/1.4 lens

Manual Focusing: Visually on Acute-Matte viewfinder screen and/or by monitoring viewfinder focus indicators

Metering: TTL type, with three selectable modes: multi-pattern, in which the metering pattern of a six-segment cell is modified based on input from the autofocus system, center-weighted average, and spot; six-segment silicon photocell (SPC) on pentaprism for ambient light; second SPC at bottom of mirror box for TTL flash metering

Autoexposure (AE) range: EV 0 to 20 with ISO 100 film and 50/1.4 lens

Exposure Modes:

Program AE: Automatic multi-program selection sets autoexposure program, based on lens focal length in use; shutter speed and aperture determined by autoexposure (AE) program

Shutter-priority AE: Any speed from 1/8000 to 30 sec., selectable in full stops, aperture set automatically by autoexposure program

Aperture-priority AE: Any available aperture selectable in half-stops, shutter speed set steplessly from 1/8000 to 30 sec. automatically by autoexposure program.

Manual: Any shutter speed and aperture combination usable: correct exposure and under-/over-exposure indicated in viewfinder, "bulb" setting for long exposure.

TTL Flash Metering: Operates in all exposure modes with dedicated units; shutter X-sync speed set automatically when flash-on signal appears in viewfinder; in P or A modes, pressing spot-metering button sets slower shutter speed (down to 30 sec.) for increased background exposure

Program AE: Automatic setting of aperture and shutter speed between 1/200 and 1/20 sec. according to lens focal length; flash fires automatically when required.

Shutter-priority AE: Same as Program AE mode.

Aperture-priority AE: Shutter speed automatically set to 1/200 sec.; any available aperture usable.

Manual: Any shutter speed 1/200 or slower, and any available aperture usable; speed automatically reset to 1/200 sec. when flash-on signal appears if manually set speed is higher.

Exposure Controls: Exposure adjustment; range: ± 4 stops, set in half-stop increments; program shift in half stops for temporary selection of other programmed aperture-shutter speed settings; multiple exposure function

Shutter: Electronically controlled vertical traverse focal-plane type; automatic speeds: in program and aperture-priority AE modes, stepless 1/8000 to 30 sec. with nearest half-stop setting displayed; in shutter-priority AE and manual modes, 1/8000 to 30 sec. in full-stop settings; **bulb**, in manual mode, for long exposures

Shutter-release button: Pressing button part-way down activates autofocus and metering systems; pressing button all-the-way down releases shutter; in AF mode, shutter can be released only when subject is in focus (focus-priority operation)

Controls: Buttons for manual start of film rewind, self-timer, focus hold, spot metering; focus-mode switch; setting control for program shift, aperture (A mode), shutter speed (shutter-priority AE mode and manual mode); setting control in combination with a second control for: manual film speed settings, metering pattern, drive mode, focus area, exposure mode, exposure adjustment, aperture (manual exposure mode), and multiple exposure; pressing program reset button sets camera to program mode, single-frame advance, autofocus with wide focus area, and cancels any exposure adjustment and self-timer or multiple-exposure settings

Film-speed setting: Automatic setting for DX-coded ISO 25 to 5000 film; for films without DX coding, previous film-speed setting is retained; manual setting in 1/3 stop increments from ISO 25 to 6400

Film Transport: Automatic with built in motor drive: auto threading, auto advance to first frame, single frame advance or continuous advance at up to 3 frames per second, automatic rewind and manual start of automatic rewind; advancing frame counter in data panel; shutter lock and data panel display when film is loaded incorrectly

Viewfinder: Eye level fixed pentaprism shows 92% of vertical by 94% of horizontal field of view; magnification 0.75X with 50mm lens at infinity; standard acute-matte screen (Type G) shows wide/center focus areas and spot metering area on matte field

Data Displays:

Data Panel: Liquid-crystal display (LCD) includes indicators for film speed, shutter speed, card name (when card is activated), exposure adjustment, aperture, exposure mode, manual focus, battery condition, self-timer, frame number, film transport, metering pattern, drive mode, focus area, multiple exposure and active card; automatically illuminated in low light

Viewfinder: LED focus and flash-on indicators, and flash-ready signal; illuminated LCD readout for focus area, shutter speed, film speed (when set), card name (when activated), exposure adjustment, over-/under-exposure (manual exposure mode), aperture and meter pattern

Power: 6-volt 2CR5 lithium battery powers camera; automatic battery check when camera is turned on; battery condition indicated by four-stage indicator in data panel; shutter locks when battery is exhausted; main switch with LOCK and ON positions

Self-timer: Electronic with 10-second delay; cancelable; operation indicated by blinking LED

Others: Cushioned eyepiece frame, eyepiece cap, film window, remote-control socket, carrying strap

Size and weight: 153 x 93 x 69mm; 600g without lens and battery

Optional Accessories: Accepts all Minolta AF lenses, Program Flashes 2000i, 3200i and 5200i, Macro Flash 1200 AF Set-N, Creative Expansion Cards, Data Back DB-7, Program Back PB-7, Wireless Controller IR-1N Set, dioptric eyepiece correction lenses, Remote Cord RC-1000 L and Remote Cord RC-1000 S, Eyepiece Correctors, and flash accessories including off-camera cables and connectors, user-changeable Acute-matte Focusing Screens 7.

Specifications subject to change without notice.

13. CARE AND STORAGE

- Always keep your camera in its case with the lens capped when not in use, or with a body cap on when a lens is not attached.
- No part of the camera should be forced at any time.
- 72-exposure cartridges and Polaroid instant 35mm films cannot be used.
- Never subject your camera to shock, high heat, humidity, water, or harmful chemicals. Be particularly careful not to leave it in the glove compartment or other places in motor vehicles where it may be subjected to high temperatures.
- Never lubricate any part of the camera body or lens.
- Never touch the shutter curtains, mirror, or the front inside parts of the body or clean them with compressed air. Doing so may impair their alignment and movement.
- External camera surfaces and lens barrel - but not glass surfaces- can be cleaned by wiping with a dry or silicone-treated cloth. After use at the seashore, use a cloth moistened with a small amount of fresh water to remove any accumulated salt, then wipe dry with a clean cloth. Never use organic solvents to clean the camera.
- Never touch the lens or eyepiece surfaces with your fingers. Whisk away loose matter with a blower brush. To remove stubborn spots, use a sheet of photographic lens tissue. If necessary, tissue may be moistened with one drop of lens-cleaning fluid; Never place fluid directly on glass surfaces.
- We recommend that you have your camera cleaned once a year at an authorized Minolta service facility.
- If you plan to store your camera for an extended period of time, rewind and remove the film, then remove the battery. Place the camera in a cool, dry place away from dust or chemicals, preferably in an airtight container with a drying agent such as silica gel. Also, it is recommended that you periodically release the camera's shutter to maintain proper working condition.