

This manual is for reference and historical purposes, all rights reserved.

This page is copyright© by M. Butkus, NJ.

This page may not be sold or distributed without the expressed permission of the producer

I have no connection with any camera company

On-line camera manual library

This is the full text and images from the manual. This may take 3 full minutes for the PDF file to download.

If you find this manual useful, how about a donation of \$3 to: M. Butkus, 29 Lake Ave., High Bridge, NJ 08829-1701 and send your e-mail address so I can thank you. Most other places would charge you \$7.50 for a electronic copy or \$18.00 for a hard to read Xerox copy.

This will allow me to continue to buy new manuals and pay their shipping costs.

It'll make you feel better, won't it?

**If you use Pay Pal or wish to use your credit card,
click on the secure site on my main page.**

PayPal Name Lynn@butkus.org

INSTRUCTION BOOK

PETRI[®] 7S





SUPERLATIVE FEATURES OF PETRI 7S 1.8 & 2.8

- Type :** 35 mm camera with coupled built-in exposure meter.
- Film Size :** 35 mm film (20 or 36 exposures).
- Lens :** Petri 45 mm f 1.8 (or f 2.8) amber-coated lens.
- Shutter :** Petri MVE shutter with speeds: B, 1, 1/2, 1/4, 1/8, 1/15, 1/30, 1/60, 1/125, 1/250, 1/500 second.
Self cocking, MX synchronization, built-in selftimer, release pressure 200 g.
- Exposure System :** Zero method reflection type; fully coupled 'Circle-Eye' exposure meter. Needle visible on the top of the camera body and in the view finder.
- Rangefinder :** Helicoid-type Coupled Rangefinder. Focusing from 2.65 ft to infinity.
- Viewfinder :** Bright-line type. Parallax Correction mark.
- Film Transport :** Single-stroke (180°) rapid transport lever which automatically transports film and cocks the shutter.
- Film Rewind :** Crank rewinding system.
- Others :** Automatic resetting film-counter, hinged camera back.

INDEX

Superlative Features of Petri 7S 1.8 & 2.8...	2
Description of parts	4
Film Loading	6
How to use the Exposure Meter	9
Points on using the Exposure Meter	12
How to Focus	13
How to hold the Petri 7S	14
Flash Photography	15
How to use the Selftimer	16
Depth of Field	16
Unloading the Film	18
Accessories	19



DESCRIPTION OF PARTS

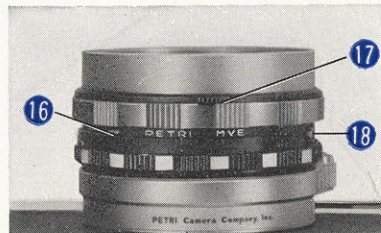
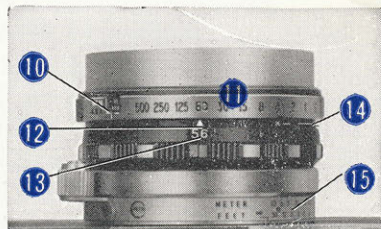

www.butkus.us

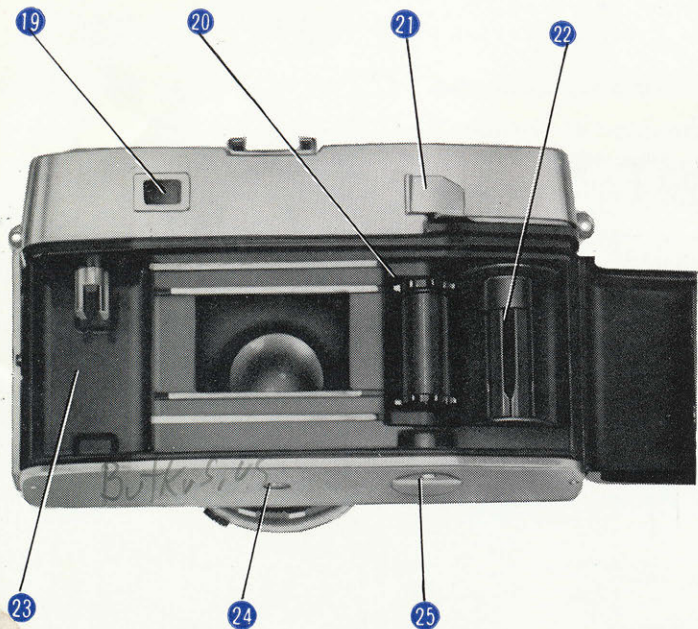

1. Film Counter
2. Shutter Release Button
3. Exposure Meter Needle
4. Accessory Shoe
5. GREEN-O-MATIC Viewfinder
6. Film Rewind Crank
7. Neck Strap
8. Circle-Eye Photocell
9. Focusing Lever
10. Film Speed Indicator
11. Shutter Speed Dial
12. Shutter Speed & Diaphragm Setting
13. Diaphragm Ring
14. MX Switch
15. Distance Scale
16. Selftimer
17. Film Speed Setting Lever
18. Flash Socket
19. Eye Piece
20. Sprocket
21. Film Advance Lever
22. Take-up Spool
23. Film Cassette Chamber
24. Tripod Bush
25. Film Rewind Button

FILM LOADING



Opening the camera back.

Pull out the lever at the side of the camera with your thumb-nail, and the cover will automatically be released.



The rewind crank.

Pull out the rewind crank as far as it will go.

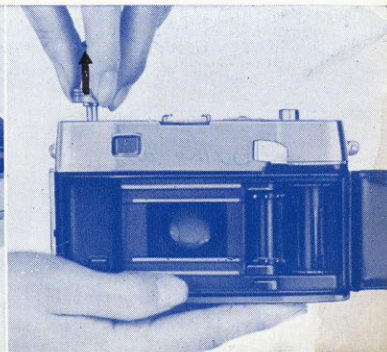

Film Loading

Slip the film end into any slit on the Take-up Spool and slide it down toward the bottom of the camera body.

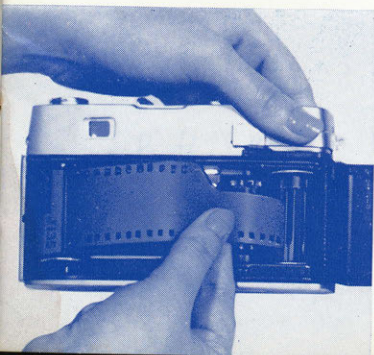

Advance the film.

Place the cassette into the film compartment. Advance the film until the perforations on both edges are engaged with the camera sprockets.

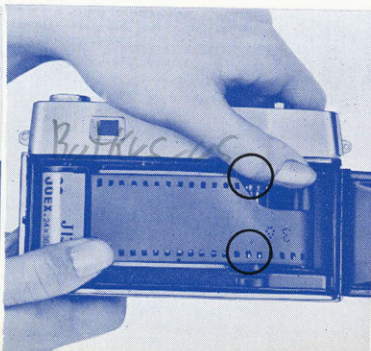

Closing the camera back

Return the rewind crank to its original position. Check that the film is in the correct position and close the camera back.

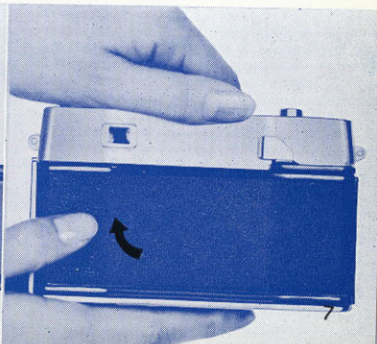

Film counter mechanism.

When you close the camera back the counter mechanism automatically shows the letter 'S' for start.

For your first picture.

Advance the film and release the shutter. Repeat this action until No. 1 appears in the film counter mechanism. You are now ready to take pictures.

Points on film loading

Avoid loading in direct sunlight. Always do this in the shade. It is most important that the film runs correctly over the camera sprockets into the take-up spool.

To check that the film is winding on, observe the rewind crank, when advancing the film. It should revolve in the opposite direction to the indicator arrow.

When you advance one frame of the film, the shutter is simultaneously cocked. As you release your hold of the lever, it returns to its original position.

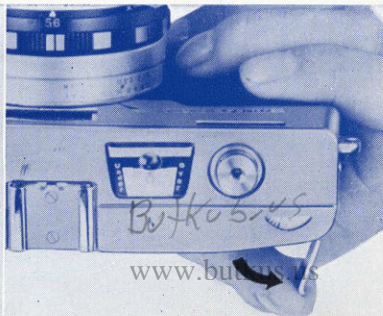
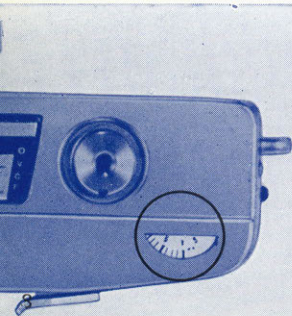

HOW TO USE THE EXPOSURE METER

The exposure meter is coupled with 3 elements: shutter speed, film speed and aperture. Its features are as stated below.

ASA film speeds: 10, (16), 25, (32), 50, 100, 200, 400, Range when using ASA 100 film-LV7 to LV17.

You have, therefore, the choice of both high and low speed films. When using a film rated at ASA 100, the exposure meter has a range of: f1.8 at a 1/30 sec. (LV7) for a dark subject, and f16 at a 1/500 sec. (LV17) for a bright one.

EXPOSURE METER COUPLED RANGE CHART
(ASA 100)

F No. L. V.	1.8	2.8	4	5.6	8	11	16
7	1/30	1/15	1/8	1/4	1/2	1	
8	1/60	1/30	1/15	1/8	1/4	1/2	1
9	1/125	1/60	1/30	1/15	1/8	1/4	1/2
10	1/250	1/125	1/60	1/30	1/15	1/8	1/4
11	1/500	1/250	1/125	1/60	1/30	1/15	1/8
12		1/500	1/250	1/125	1/60	1/30	1/15
13			1/500	1/250	1/125	1/60	1/30
14				1/500	1/250	1/125	1/60
15					1/500	1/250	1/125
16						1/500	1/250
17							1/500

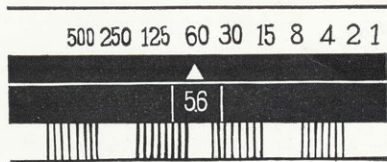

- 1.** Adjust the film speed indicator according to the ASA (DIN) of film in use. This operation should be carried out before or after loading the film.

- 2.** Select the shutter speed that you require. Use fast speeds for bright subjects and slow speeds for dark subjects.

www.butkus.us

The needle visible in the viewfinder

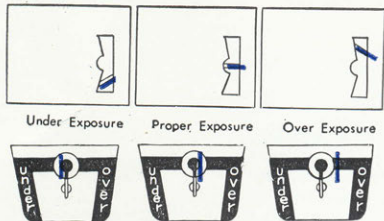

The needle visible on top—cover

Butkus US

3. Point the Petri 7S toward the subject and adjust the aperture ring until the exposure needle meets the indicator mark in the viewfinder. You can also use the exposure indicator located on the top of the camera body.

CIRCLE-EYE System and Filter Factors

Filters for the Petri 7S fit over both the Circle-Eye exposure meter and the lens. Adjustments for the filter factor are not therefore necessary, as this is automatically compensated for.

POINTS ON USING THE EXPOSURE METER

Sometimes, when you are photographing dark subjects, you may not be able to adjust the exposure needle to the indicator mark. On this occasion use a slower shutter speed.

Filters for the Petri 7S fit over both the lens and the Circle-Eye exposure meter, thus eliminating filter factor alterations.

When the subject is too dark and the camera does not give a reading, set the aperture and shutter speed manually. If the subject is too bright use a NDX4 filter (see article on filters).

Landscape photography

When taking landscapes with large expanses of sky, point the camera slightly downwards, before you take a reading. This avoids inflation of the meter, which would cause under exposure.

Portrait photography

Take a close-up reading of the subject taking care not to measure the brightness of the sky and other background objects.

If the light is strongly contrasting between light and dark areas, readings should be taken of both portions and the average figure used. It may be found convenient to use the needle on top of the camera for this type of photography.



HOW TO FOCUS



IN FOCUS

OUT OF FOCUS

After setting the correct exposure, it is necessary to adjust the focusing. As you look through the viewfinder, a yellow rectangle will be seen in the center. In this rectangle out-of-focus pictures will appear as two images. Adjust the focusing lever until one clear image is shown. Note that the bright line finder indicates the exact picture area to be photographed, and the picture composition should be selected accordingly.

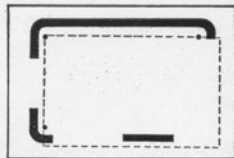

The viewfinder

As you look through the view finder you will notice a bright line frame. The subject within this frame can be photographed. However, when taking portraits or close-up shots, use the three dots in the frame as the picture border. (Parallax correction marks.)

Sequence of photography.

1. Select the shutter speed and set the aperture accordingly.
2. Adjust the focusing.
3. Select the picture-composition within the bright line finder.
4. Release the shutter button.

HOW TO HOLD THE PETRI 7S

The slightest shake of your camera greatly affects the sharpness of the picture. Cradle the camera in both hands and place the back of it against your cheek or nose. To give extra stability, draw your elbows into your side. Hold your breath and release the shutter in a smooth action.

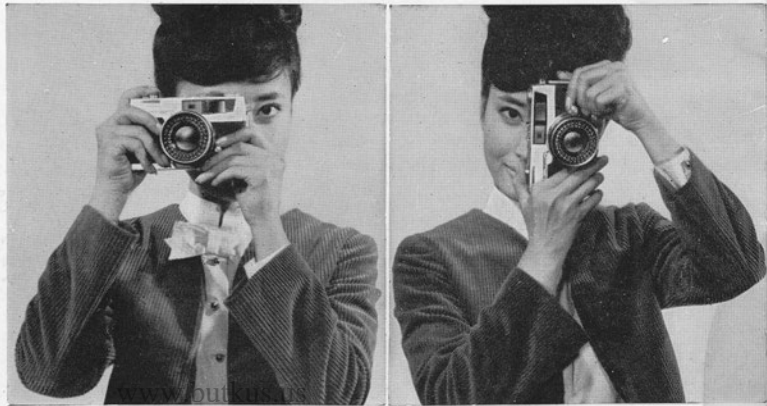

FLASH PHOTOGRAPHY

The Petri 7S has a MX shutter suitable for use with either electronic or bulb flash units. Set the flash synchronizing lever according to the unit used - X for electronic, M for flash bulbs. Connect the flash lead to the synchro flash terminal, and check that either the electronic flash is fully charged, or that the flash bulb is correctly in position. Set the shutter according to the synchronization chart opposite, and the aperture according to the bulbs or unit used - see their respective instruction for use. Focus in the normal way, and release the shutter. The Petri 7S has a universal accessory shoe, which enables you to attach your flashgun if required.

When not taking flash pictures the shutter may be set in either the M or X position.

Synchronization chart.

Flash bulb	M Synchronization	X Synchronization
M Class	All shutter speeds	1/30 sec. or slower
F Class	/	1/60 " " "
Electronic Flash	/	All shutter speeds

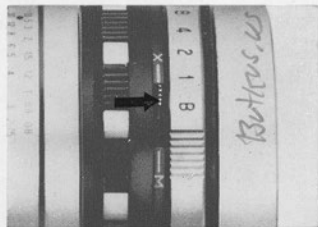

HOW TO USE THE SELFTIMER

Pull down the selftimer lever as far as it goes and release the shutter button. The film will be exposed about 8 seconds later.

The selftimer can be set either before or after the advancing the film. You can use self-timer with various speeds, but not with B.

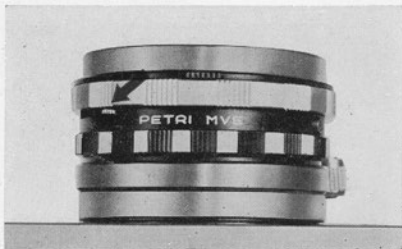

DEPTH OF FIELD

When you take a picture, you will notice that the finished result shows an area both in front of and behind the subject which is sharp. This 'Depth of field' varies according to the size of aperture used and the focal length of the lens. A small aperture and a short focal length lens give a large 'Depth of field'.

- To photograph subjects with lots of important details, as in architecture, use a small aperture. To blur out unsightly backgrounds use a wide aperture.
- To get sharp pictures, refer to the 'Depth of field'-chart opposite, which indicates the zone of sharpness of each aperture at a set distance.
- Set the aperture first. Select the shutter speed by turning the shutter speed dial until the exposure needle meets the indicator mark. Should you not be able to make the exposure needle and the indicator mark line up exactly, select the nearest shutter speed and make the final alteration by adjusting the iris diaphragm ring.

DEPTH OF FIELD TABLE (PETRI 1.8 or 2.8 45mm)

feet

FNo.	1.8	2.8	4	5.6	8	11	16
2.75	2.69 2.82	2.65 2.86	2.61 2.91	2.56 2.97	2.48 3.08	2.40 3.23	2.26 3.50
3	2.92 3.08	2.88 3.13	2.83 3.19	2.77 3.27	2.69 3.40	2.58 3.58	2.46 3.92
4	3.86 4.15	3.79 4.24	3.71 4.35	3.60 4.50	3.45 4.76	3.28 5.12	3.04 5.86
5	4.78 5.24	4.67 5.38	4.55 5.56	4.39 5.82	4.17 6.25	3.92 6.90	3.57 8.34
6	5.69 6.34	5.53 6.55	5.35 6.82	5.13 7.22	4.88 7.90	4.50 8.98	4.05 11.61
8	7.46 8.63	7.19 9.02	6.89 9.55	6.52 10.35	6.04 11.84	5.53 14.43	4.85 22.74
12	10.81 13.48	10.25 14.48	9.64 15.89	8.94 18.25	8.06 23.50	7.17 36.66	6.09 ∞
30	23.50 41.53	20.96 52.83	18.57 78.30	16.11 218.72	13.44 ∞	11.14 ∞	8.66 ∞
∞	107.57 ∞	69.22 ∞	48.46 ∞	34.60 ∞	24.21 ∞	17.61 ∞	13.00 ∞

meter

FNo.	1.8	2.8	4	5.6	8	11	16
0.8	0.78 0.82	0.77 0.83	0.76 0.84	0.75 0.86	0.73 0.89	0.70 0.93	0.66 1.01
0.9	0.88 0.92	0.87 0.94	0.85 0.96	0.83 0.98	0.81 1.02	0.78 1.07	0.73 1.17
1	0.97 1.03	0.96 1.05	0.94 1.07	0.92 1.10	0.89 1.15	0.85 1.22	0.80 1.35
1.2	1.16 1.24	1.14 1.27	1.11 1.30	1.08 1.35	1.04 1.42	0.99 1.53	0.91 1.75
1.5	1.44 1.57	1.40 1.61	1.37 1.66	1.32 1.74	1.25 1.87	1.18 2.06	1.08 2.48
2	1.89 2.13	1.83 2.20	1.77 2.31	1.69 2.46	1.58 2.72	1.47 3.15	1.31 4.25
3	2.75 3.29	2.63 3.48	2.50 3.75	2.34 4.16	2.14 5.00	1.93 6.67	1.67 15.04
5	4.34 5.89	4.05 6.54	3.74 7.52	3.40 9.43	2.99 15.19	2.60 64.52	2.13 ∞
10	7.68 14.35	6.79 18.94	5.97 30.68	5.14 ∞	4.26 ∞	3.50 ∞	2.71 ∞
∞	32.79 ∞	21.10 ∞	14.77 ∞	10.55 ∞	7.38 ∞	5.37 ∞	3.69 ∞

UNLOADING THE FILM

Rewind Button.

When you have finished the film, you must rewind it into the cassette. First press the rewind button located at the bottom of the camera body.

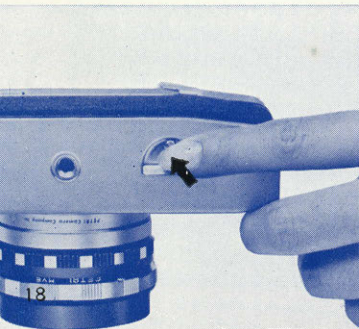

Rewind crank.

While pressing the rewind button, pull out the rewind crank. Turn it in the direction indicated by the marking, until you feel no resistance.



Removing the film.

Select a place in the shade and avoid the direct sun-light. To check that the film is fully rewound, advance the film and see if the rewind crank moves. If not, the film is in its cassette.

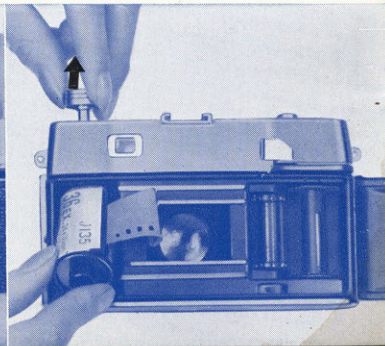

ACCESSORIES



Petri Lens Hood

The Petri lens hood has been carefully designed to prevent extraneous light from entering the lens of your camera. It is constructed of light alloy metal and smartly styled to enhance the beauty of the Petri 7S camera.

Petri Auxiliary Lens Set

Adds extra coverage to your photography. Hard coated colour corrected lenses. No adapters needed. Each set complete with auxiliary telephoto and wide angle lenses, matching viewfinder and zippered case.



Petri Filters

For Black & White Photography

- UV Colourless. Absorb excessive ultra violet rays.
- Y1 Light yellow. Landscapes, snow, clouds.
- Y2 Yellow. Same as Y1, but stronger effect.
- YA3 Orange. For photographing distant views.
- R1 Red. For dramatic cloud and landscape effects.
- PO1 Green. Landscapes. Snow, clouds.
- NDX4 Neutral density. For brilliant sunshine (colour or black & white photography).

For Colour Photography

- W4 Reduces excess blue.
- C4 Reduces red in early morning or evening shots.
- C8 For flash photography.
- C12 Daylight to artificial conversion filter.