



This manual is for reference and historical purposes, all rights reserved.

This page is copyright© by M. Butkus, NJ.

This page may not be sold or distributed without the expressed permission of the producer

I have no connection with any camera company

On-line camera manual library

This is the full text and images from the manual. This may take 3 full minutes for the PDF file to download.

If you find this manual useful, how about a donation of \$3 to: M. Butkus, 29 Lake Ave., High Bridge, NJ 08829-1701 and send your e-mail address so I can thank you. Most other places would charge you \$7.50 for a electronic copy or \$18.00 for a hard to read Xerox copy.

This will allow me to continue to buy new manuals and pay their shipping costs.

It'll make you feel better, won't it?

**If you use Pay Pal or wish to use your credit card,
click on the secure site on my main page.**

Nikon

NIPPON KOGAKU K.K.

No reproduction in any form of this booklet,
in whole or in part (except for brief quotation in
critical articles or reviews), may be made without
written authorization from the publisher.

Printed in Japan (85.3.CO)&-6

Nikon

FG-20

INSTRUCTION MANUAL

E

NOMENCLATURE

① Shutter speed/mode index

② Shutter speed/mode selector dial

③ Frame counter

④ Neckstrap eyelet

⑤ Lens mounting flange

⑥ Reflex mirror

⑦ Self-timer lever

⑧ Aperture ring

⑨ Focusing ring

⑩ Distance scale

⑪ Aperture-direct-readout (ADR) scale

⑫ Depth-of-field indicators



⑬ Meter coupling lever

⑭ Film rewind crank

⑮ Film rewind knob

⑯ Exposure compensation button

⑰ Lens mounting index

⑱ Lens release button

⑲ Meter coupling shoe

⑳ Meter coupling ridge

㉑ Mounting ring

㉒ Aperture scale

㉓ Infrared focusing index

㉔ Aperture/distance index

㉕ Contact for the Speedlight SB-19

㉖ Hot-shoe contact

㉗ Ready-light contact

㉘ ASA/ISO film speed ring

㉙ ASA/ISO film speed index

㉚ Film rewind fork

㉛ ASA/ISO film speed scale

㉜ Film cartridge chamber

㉝ Film plane indicator

㉞ Shutter curtains

㉟ Viewfinder eyepiece

㊱ Film rewind button

㊲ Motor drive coupling

㊳ Motor drive positioning hole

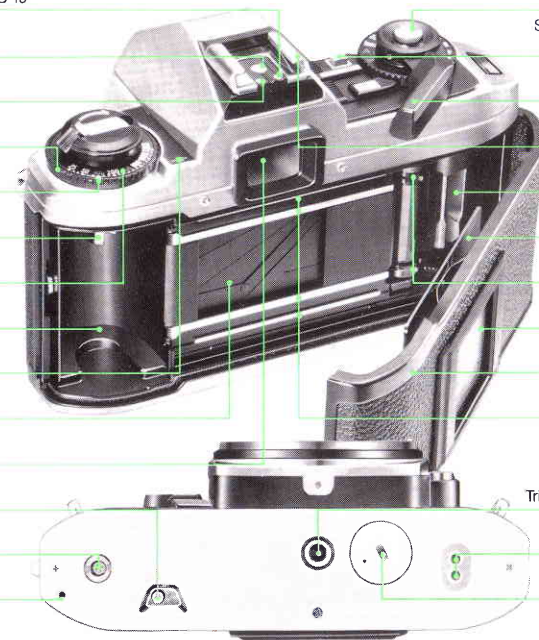

㊴ Shutter release button

㊵ Shutter speed/mode selector dial lock release button

㊶ Film advance lever

㊷ Accessory shoe

㊸ Film take-up spool

㊹ Film pressure plate

㊺ Film sprocket

㊻ Memo holder

㊼ Camera back

㊽ Film guide rails

㊾ Tripod/motor drive coupling socket

㊿ Motor drive electrical contacts

⓫ Battery clip

NOMENCLATURE	2—3
FOREWORD	5
BASIC OPERATION	6—19
CONTROLS IN DETAIL	20—31
Shutter Release Button	20
Film Advance Lever	20
Frame Counter	21
Memo Holder	21
Shutter Speed/Mode Selector Dial	22—23
Focusing Screen	24—25
Exposure Viewfinder Information	26—27
Exposure Compensation Button	28
Self-Timer Lever	29
Film Plane Indicator	30
Infrared Focusing Index	30
Meter Coupling Lever	31
For lenses or accessories without automatic diaphragms	31
For fixed-aperture lenses, photomicrography, or astrophotography	31
TECHNICAL INFORMATION	32—42
Relationship Between Shutter Speed and Aperture	32—33
Depth of Field	34—35
EV Range of the Camera	36
What is EV?	36
EV range	36
Exposure Compensation	37—39
In the manual mode	37
Duplication work and photomicrography	38—39

Flash Photography	40—42
Ready-light indication in the viewfinder	41
Relationship between the camera's meter, ready-light indication and shutter speed	41
Nikon FG-20/Speedlight combination chart	42
ACCESSORIES	43—48
Electronic Flash	43
Nikon Speedlight SB-19	43
Motor Drives	44
Nikon Motor Drive MD-14 and MD-E	44
Close-Up Equipment	45
Filters	46
Lens Hoods	46
Eyepiece Correction Lenses	47
Rubber Eyecup	47
Eyepiece Adapter	47
Anti-Cold Battery Pack DB-2	47
Cable Release AR-3	47
Semi-Soft Camera Cases	48
Neckstraps	48
TIPS ON BATTERY USE	49
TIPS ON CAMERA CARE	50—51
SPECIFICATIONS	52—53
USABLE LENSES	54
WHAT IS AI?	55

Welcome to Nikon's world of picture-taking ease. With your new FG-20 it's easy to take the type of high-quality photographs which have become synonymous with the Nikon name.

The FG-20 features automatic exposure control. Just set the camera to A, select a shooting aperture on the lens, and fire away. The FG-20 then instantaneously sets the proper shutter speed for correct exposure steplessly over the range of 1 to 1/1000sec. If you desire, you can set the shutter speed dial to the  mark. Then an audible warning is provided to let you know when the scene is too bright to get correct exposure or when the shutter speed is around 1/30sec. or slower, indicating that you should use a tripod. Moreover, the FG-20 offers full manual control of all shutter speeds for creative experimentation; in addition there are two mechanical settings—M90 (1/90 sec.) and B (bulb)—which do not require battery power.

Before using your camera, please read this instruction manual from cover to cover. A few minutes invested now will pay off in years of rewarding picture-taking experiences.

BASIC OPERATION

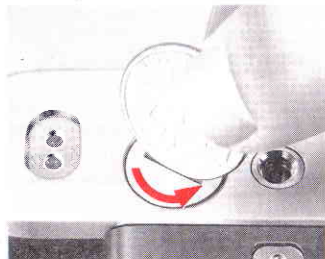

1. Remove the battery clip .

Use a coin to unscrew it in a counterclockwise direction.

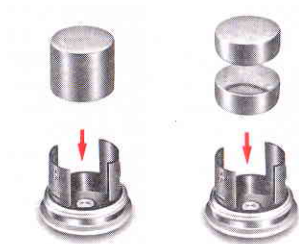

2. Insert batteries.

Wipe the battery terminals clean and insert the batteries, **making sure that the + signs are up.**

Usable batteries for the Nikon FG-20 are:

- One 3V lithium battery (CR-1/3N)
- Two 1.55V silver-oxide batteries (SR44)
- Two 1.5V alkaline-manganese batteries (LR44)

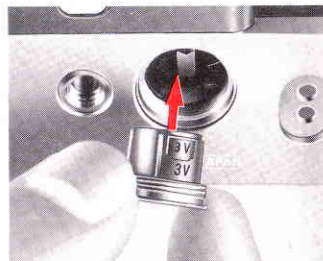

3. Reattach the battery clip.

Slip the clip back into the camera body and screw it tightly into place.

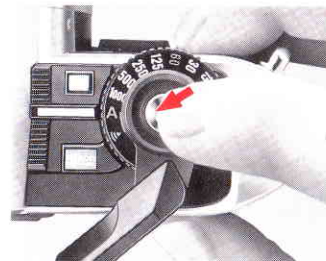

4. Depress the shutter release button halfway to activate the exposure meter.

Make sure to remove the camera body cap.



Sufficient battery power



Insufficient battery power

5. Check the meter needle in the viewfinder.

Make sure the needle is above the bottom red zone. This indicates that battery installation is correct and power is sufficient. If the needle is in the red zone, recheck battery orientation or, if necessary, replace with a new set.

With sufficient battery power, the needle remains above the red zone for approx. 20sec. after you take your finger off the button. If the batteries are almost depleted, the needle will drop back into the red zone immediately after you take your finger off the button. In this case, replace the batteries as soon as possible.

- To check battery power, set the shutter speed/mode selector dial  at any setting except M90 and B.

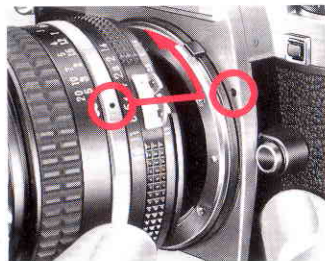

6. Mount the lens onto the camera.

Lenses which are usable with the Nikon FG-20 are AI-S Nikkor, Nikon Series E, AI-Nikkor, most AI-modified Nikkor, and certain special lenses. (For details about usable lenses, refer to page 54.)

To mount a lens, first line up the aperture/distance index ⑭ on the lens with the lens mounting index ⑮ on the camera body. Then twist the lens mounting ring ⑯ counterclockwise until the lens clicks into place. Check to see that the aperture/distance index is exactly at the top.

To remove: While pushing the lens release button ⑰, turn the lens mounting ring clockwise until the lens comes off.

- *With film loaded in the camera, be careful not to expose the mirror box to direct sunlight while you are changing lenses.*



7. Open the camera back ⑱.

Pull up the film rewind knob ⑮ until the camera back pops open.

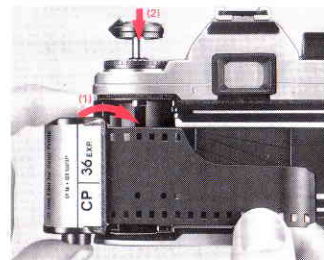

8. Install the film cartridge.

Position the cartridge in the film cartridge chamber ⑳ with the leader pointing towards the takeup spool ㉓; then push the rewind knob back down to hold the cartridge in place.

The FG-20 accepts any type of 35mm film on the market. During film loading, it is advisable to handle the film in the shade to avoid direct exposure to sunlight.

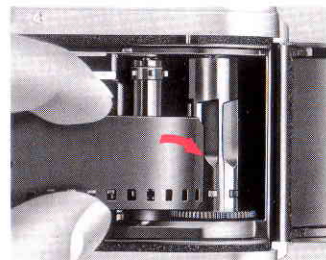

9. Insert the film leader into the takeup spool.

Pull the leader and insert it into any one of the slots in the takeup spool.

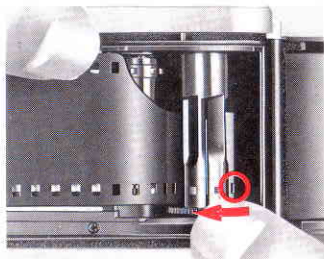

10. Engage the film perforations with the sprocket teeth ④.

Turn the takeup spool slightly with your thumb, so that a perforation at the bottom edge of the film is engaged with the small tooth at the bottom of the slot in the takeup spool, and the top and bottom perforations mesh securely with the sprockets.

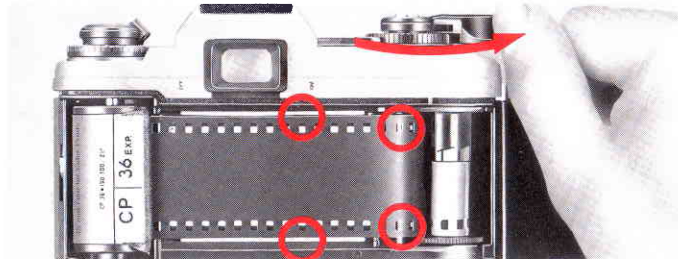

11. Advance the film with the film advance lever ④.

Wind the film advance lever and depress the shutter release button **until the film sprockets engage the perforations on the edges of the film. Confirm that the film is properly seated between both film guide rails ④ and there is no film slack.** Then close the camera back until it snaps shut.



12. Take up the film slack.

Fold out the film rewind crank ④ and rotate it slowly in the direction of the arrow on the film rewind knob until you feel slight resistance. Then fold the crank back in.

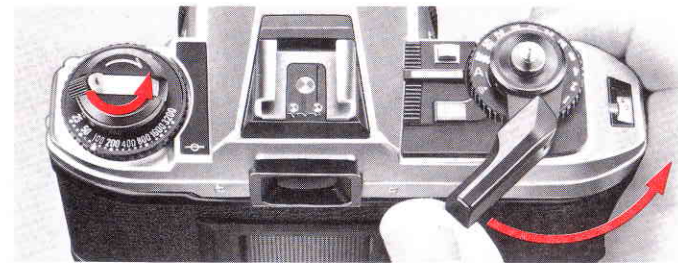

13. Make blank exposures.

To dispose of the first few frames exposed during film loading, continue to alternately advance the film and depress the shutter release button until the frame counter ③ reaches frame 1. While making blank exposures, **check that the rewind knob is rotating, indicating the film has been loaded correctly and is advancing.** If the knob does not rotate, reload the film.

• Before the frame counter reaches frame 1, with the shutter speed/mode selector dial set at A or the ∞ mark, the shutter fires at a fixed speed of 1/90sec. regardless of scene brightness. To indicate blank exposures, the shutter speed needle in the viewfinder points to C90. At a manual shutter speed setting, the shutter fires at the speed set on the dial although the meter needle will not necessarily point to that speed.



14. Set the film speed.

Lift up the ASA/ISO film speed ring ⑳ and rotate it in either direction **until the white index dot ㉑ is opposite the film speed in use.**

The scale ㉒ on the ASA/ISO dial has settings from ASA/ISO 25 to 3200. Two dots between each number stand for intermediate settings, such as 64, 80, etc. As a convenience, the most popular film speeds of 64, 100, 400, and 1000 are in red.

The film speed, in the form of an ASA/ISO number, is printed on the film carton and also on the cartridge itself. This number is a numerical rating of the film's sensitivity to a given amount of light; the higher the number, the greater the sensitivity, and vice versa.

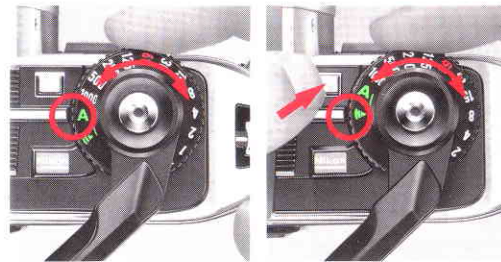

15. Set the shutter speed/mode selector dial to A or 1/30.

Both settings indicate automatic exposure operation. **At 1/30, an audible warning is provided to let you know when the scene is too bright or too dark to get correct exposure or when the shutter speed is around 1/30sec. or slower, indicating that you should use a tripod.**

A locking mechanism is provided between the A and 1/30 setting. To move from A to 1/30 or vice versa, depress the lock release button ㉓ as you rotate the dial.

• For manual shutter speed settings from 1/1000sec. to 1sec., refer to page 23.



16. Set the lens to the desired aperture.

With a 50mm f/1.4 lens and ASA/ISO 100 film, use the following suggestions in setting the f/stop on the lens.

- Indoors: f/1.4—f/4
- Outdoors (cloudy): f/4—f/8
- Outdoors (clear): f/8—f/16



17. Hold the camera steady.

Many blurred shots are caused by unsteady holding of the camera. The basic shooting posture is this: Cradle the camera in your left hand with your fingers wrapped around the lens barrel and your elbow propped against your body for support. Then grasp the end of the camera body in your right hand with the index finger on top of the shutter release button and the thumb between the camera film advance lever. You can look through the viewfinder with either eye, while you can keep your other eye opened or closed. It's easy to adapt this basic posture to both horizontal- and vertical-format shooting.

For maximum stability, stand with your feet flat on the ground and slightly apart; also when using slow shutter speeds, try to lean against something stable, such as a tree, fence post, or wall.



18. Center the main subject and focus on the subject.

Because the Nikon FG-20's exposure meter is centerweighted, compose the picture with the main subject at the center. The Type K clear-matte focusing screen is provided as standard. Turn the focusing ring ⑨ until the two halves of the split image rangefinder coincide perfectly to form a single unbroken image and the image in the microprism appears sharp. Correct focus will then be secured.

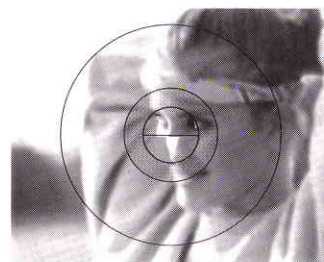

Out of focus

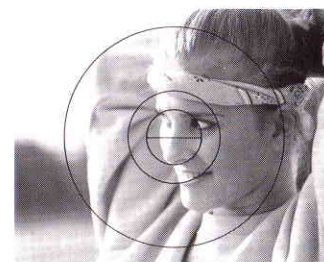

In focus

BASIC OPERATION—continued

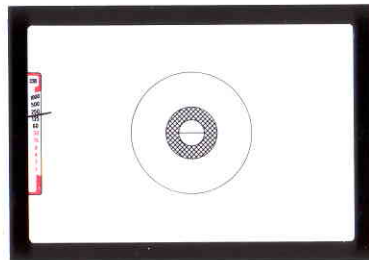

Overexposure

Correct exposure

Possible picture blur

Underexposure

19. Check the exposure.

Depress the shutter release button halfway to activate the exposure meter. **If the meter needle in the viewfinder points to any number between 1 and 1000 (indicating shutter speeds from 1 to 1/1000sec.), you can get correct exposure at the aperture selected.** Note that, however, a slow shutter speed causes blurred image. With the shutter speed/mode selector dial set at (M), the audible warning sounds if the shutter speed is around 1/30sec. or

slower (For more information on avoiding blurred images, see page 32.) If the meter needle stays in the red zone at the bottom (underexposure warning zone) or swings up to the red zone at the top (overexposure warning zone), under- or overexposure will occur at the aperture you have set. In this case, reset the lens to a larger or smaller aperture as the case may be. Note that with the dial at (M), the audible warning also sounds to indicate under- or overexposure.

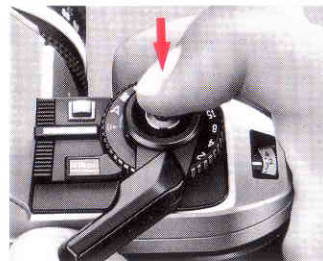

20. Take the picture.

To take a shot, trip the shutter by pushing the shutter release button all the way down; apply light but steady pressure with the ball of your index finger to avoid camera shake which might result in blurred images.

- If you trip the shutter in darkness or with the lens cap attached, the shutter remains open. In this case, reset the shutter speed/mode selector dial to a manual setting.

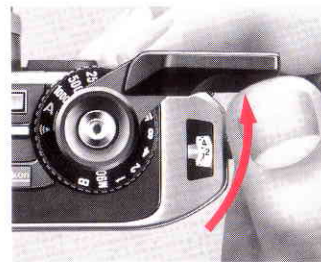

21. Advance the film.

Stroke the film advance lever to transport the film to the next frame.

- If the lever becomes difficult to operate at the beginning of the roll, this means that the film is not winding onto the take-up spool properly. In this case, rewind the film immediately and load it again.

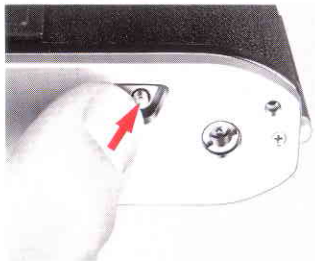

22. Depress the rewind button .

When the film reaches the end of the roll, the film advance lever cannot be wound any further. When this happens, do not force the film advance lever any further but prepare to unload the film.

Turn the camera upside down and depress the film rewind button, so that the exposed film can be rewound back into its cartridge. You don't have to apply continuous pressure to the button; just press it once.

- If the film rewind button is depressed before the film reaches the end of the roll, advance the film by one frame in darkness or with the lens cap attached to reset the button.



23. Rewind the film.

Fold out the film rewind crank and turn it in the direction of the arrow. When you feel the tension lessen, give it a few more turns until the crank turns freely, indicating the film leader is rewound completely back into the cartridge.



24. Open the camera back and take out film cartridge.

Avoid unloading in direct sunlight. If there is no shade available, turn your back to the sun and use your own shadow to shield the camera.

CONTROLS IN DETAIL

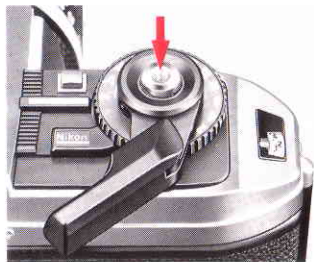

Shutter Release Button ③⑨

Depressing the button halfway switches on the exposure meter and activates the viewfinder exposure information. The meter stays on for approx. 20sec. even after taking your finger off the button; then turns itself off automatically to conserve battery power. Depressing the button all the way down releases the shutter.

The shutter release button is threaded in its center to accept a standard cable release for tipping the shutter when the camera is mounted on a tripod.

- The shutter cannot be tripped unless the film advance lever ④① is stroked completely to cock the shutter.

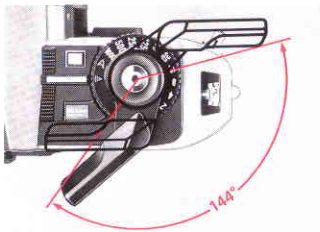

Film Advance Lever ④①

To advance the film, wind the lever to the right completely until it stops. The lever returns to the standoff position as soon as you take your thumb off the lever. A single complete stroke or a series of shorter ones advances the film one frame and simultaneously cocks the shutter.

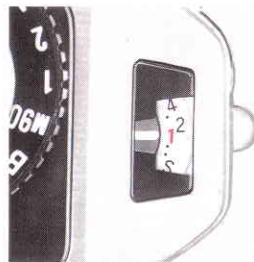

Frame Counter ③

The additive-type frame counter is graduated from S, two dots, 1, 2, 4, up to 36 in even numbers with odd numbers indicated by black dots in-between. The frame counter advances a single frame with one complete stroke of the film advance lever. After reaching frame 36 of a 36-exposure roll of film, the counter will stop operating; however, the film can still be advanced until the end of the roll is reached. When the camera back ④⑦ is opened after rewinding the film, the frame counter automatically resets to S to make the camera ready for the next roll of film.

- Before the frame counter reaches frame 1, with the shutter speed/mode selector dial set at A or (1/90), the shutter fires at a fixed speed of 1/90sec. At a manual shutter speed setting, the shutter fires at the speed set on the dial.

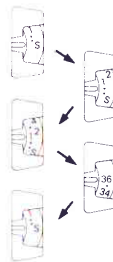

Memo Holder ④⑥

To remind yourself of the type of film and number of exposures, clip off the end of the film carton and insert it into the memo holder. Of course, you can use the holder to store something else, such as a handwritten note.

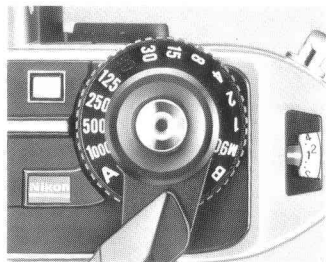

Shutter Speed/Mode Selector Dial ②

The Nikon FG-20 offers aperture-priority automatic mode operation and manual control of all shutter speeds from 1 to 1/1000sec., including the M90 (mechanically controlled 1/90sec.) and B (bulb) settings. To set the desired shooting mode or shutter speed, rotate the shutter speed/mode selector dial until the desired setting click-stops opposite the shutter speed/mode index ①. At the A (for automatic operation) and (▶ (for automatic operation with an audible warning), a locking mechanism is provided to prevent accidental shifting of the setting. To rotate the dial from the A or (▶ setting, depress the lock release button ④. You must also depress the lock release button to move the dial from A to a manual shutter speed. However, to move the dial from a manual setting back to A, it is not necessary to depress the

button. Note that shutter speeds between engraved numbers (i.e., intermediate speeds) should not be used. The dial has the following settings:

(▶ (auto with audible warning):

Used for aperture-priority automatic mode shooting. You manually set the f/stop first; then the camera automatically selects the matching electronically controlled shutter speed steplessly between 1 and 1/1000sec., depending on the scene brightness and the film speed in use. An audible warning is provided to let you know when the scene is too bright or too dark to get correct exposure or when the shutter speed is around 1/30sec. or slower, indicating that you should use a tripod.

• *When using a tripod, be careful not to screw it into the camera's tripod socket ⑨ too tightly, as this might damage the camera.*

A (auto):

Same as the (▶ setting but without an audible warning.

1/1000—1 sec. (manual):

Used for full manual control of both the f/stop and shutter speed. Numbers on the dial are reciprocals, e.g., 1000 means 1/1000sec., 500 means 1/500sec., and so forth. 60 is engraved in red to indicate the fastest sync speed when using electronic flash units other than Nikon dedicated Speedlights. Manual settings are used in the following cases:

1. When using a separate exposure meter.
2. When intentionally over- or underexposed photos are desired.
3. When manual exposure compensation is necessary (see page 37 for more details).
4. When taking creative fill-in flash shots with Nikon dedicated Speedlights where you want to use shutter speeds of 1/60 sec. or slower.

• **Even at manual settings, the meter needle doesn't show the shutter speed set on the dial but it indicates the correct shutter speed, according to the scene brightness, the aperture set on the lens, and film speed in use.**

• *Intermediate settings on the shutter speed/mode selector dial cannot be used while those on the lens aperture ring ⑧ can be. Therefore, stop the lens aperture down or open it up to the appropriate intermediate setting when fine adjustment of the exposure is necessary.*

M90 (mechanical 1/90 sec.):

At this setting, the shutter operates mechanically at 1/90sec. This setting allows you to take pictures even when the batteries are exhausted. It can also be used for electronic flash photography with units other than Nikon dedicated Speedlights.

B (bulb):

At this mechanical setting, the shutter curtains ⑭ remain open for as long as you depress the shutter release button. The B setting is especially useful when making long time exposures with a cable release with the camera mounted on a tripod.

• **To prevent inadvertent battery drain, you should set the shutter speed/mode selector dial to M90 or B when the camera is not in use. That way, even if the shutter release button is depressed, the meter will not be activated.**

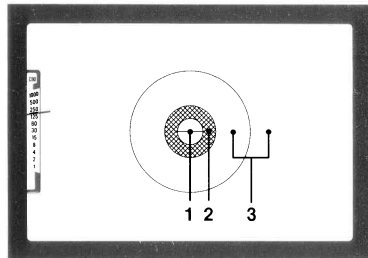

1. Split-image rangefinder
2. Microprism collar
3. Matte field

Focusing Screen

To handle a variety of photographic situations, the FG-20 comes equipped with the Type K clear-matte focusing screen, consisting of a split-image rangefinder and microprism collar in the center of an overall matte field.

While looking through the viewfinder, turn the focusing ring ⑨ of the lens until the subject looks clear. For precise pinpoint focusing on subjects with distinct contours, use the central split-image rangefinder; turn the focusing ring until the split image becomes whole (A). For rapid focusing and for subjects with indistinct outlines, use the microprism collar; turn the focusing ring until the shimmering image becomes

sharp (B). In close-up photography at high magnifications or when using telephoto lenses with maximum apertures of $f/11$ or smaller, the split-image rangefinder and microprism collar are likely to darken. Therefore, use the matte portion of the screen; turn the focusing ring until the image looks sharp (C). The Matte field can also be used for focusing when shooting fast-moving subjects.

• Because the FG-20's finder coverage is approx. 92%; the actual image size of your negatives will be slightly larger than the image seen in the viewfinder.

(A) Split-image focusing

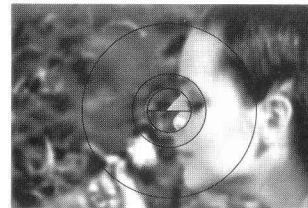

Out of focus

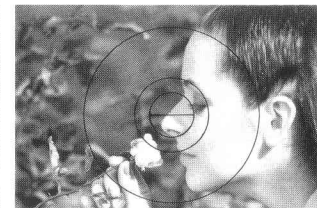

In focus

(B) Microprism grid focusing

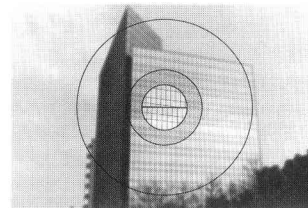

Out of focus

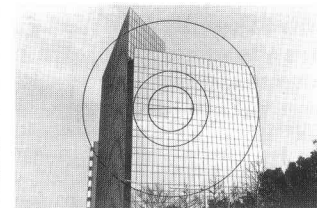

In focus

(C) Matte outer field focusing

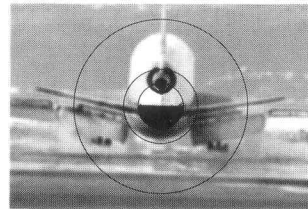

Out of focus

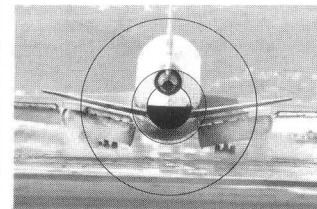

In focus

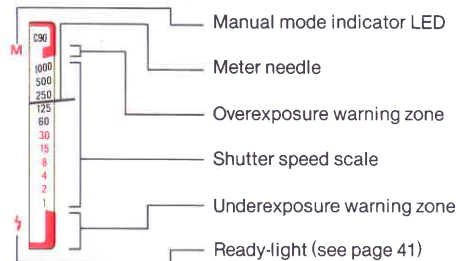
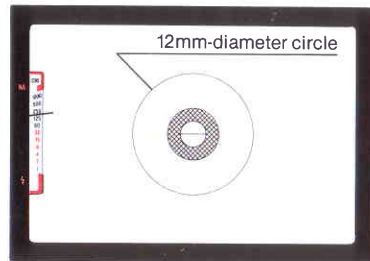

Exposure Viewfinder Information

12mm-diameter circle. The Nikon FG-20 employs through-the-lens (TTL) centerweighted full-aperture exposure metering. This means that light passing through the lens is measured at maximum aperture, thus assuring a bright finder image during shooting. Special emphasis is placed on the brightness in the 12mm-diameter central area. So, by placing the main subject in the center of the frame, you can get the correct exposure in most situations.

Meter needle. As soon as the shutter release button is depressed halfway to activate the meter, the needle automatically shows the exposure information.

Shutter speed scale. In both the automatic and manual exposure modes, the meter needle indicates the correct shutter speed, according to the scene brightness, aperture set on the lens and film speed in use.

• *For shooting moving subjects, the FG-20 lets you select fast shutter speeds on auto for freezing the action or slow ones for producing an intentional blur. To operate the FG-20 in this way, turn on the exposure meter by depressing the shutter release button halfway and then rotate the lens aperture ring clockwise or counterclockwise until the meter needle points to the desired shutter speed.*

Underexposure warning zone. If the needle stays in the red zone at the bottom left of the viewfinder, this means the scene is too dark to get correct exposure with the aperture you selected. To prevent underexposure, select a wider aperture or, if necessary, attach an electronic flash. As a last resort, change to a faster film.

• *If the needle stays in the underexposure warning zone even with a bright scene at a setting other than M90 or B, this indicates that the batteries are exhausted. At the M90 or B setting, the needle stays in this zone.*

Overexposure warning zone. If the needle is in the overexposure warning zone, this means the scene is too bright to get correct exposure with the aperture selected. To prevent overexposure, stop the lens down until the needle drops down into shutter speed scale. If all else fails, attach a neutral density (ND) filter to the lens or change to a slower speed film.

Manual mode indication LED. This LED (red M) lights up after the meter is turned to indicate when the shutter speed/mode selector dial is set to a manual setting.

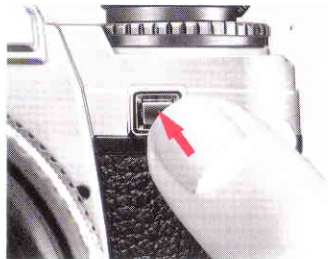

Exposure Compensation Button ⑯

To get the correct exposure when shooting snow scenes or backlit subjects on auto, you should use the exposure compensation button to increase the exposure by +2 EV. Simply keep the exposure compensation button depressed as you take the picture. Automatically the shutter speed will be shifted two stops slower (e.g., from 1/250sec. to 1/60sec.).

- For situations in which it is difficult to get the correct exposure even with the use of the exposure compensation button, refer to page 37.

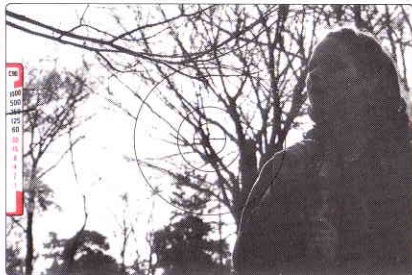

Self-Timer Lever ⑦

This device is useful when you want to include yourself in your pictures. To activate the self-timer, pull the self-timer lever up as far as it will go. This can be done either before or after the film is advanced. Now that the self-timer has been set, just depress the shutter release button. Immediately the reflex mirror ⑥ will rise and the self-timer will start to operate; the shutter then fires approx. 10sec. later. If you want to cancel the self-timer's operation after the lever has been set, move it slowly back to its original position. Then you can take pictures in the normal way. However, once you have depressed the shutter button you cannot

cancel operation, because returning the self-timer lever to its original position will immediately trip the shutter.

The self-timer can be used at any shutter speed/mode selector dial setting except B.

- When using the self-timer with the camera on auto, be sure to keep your eye at the viewfinder eyepiece ⑳ or cover it with the palm of your hand as you depress the shutter release button. This will prevent stray light from entering the eyepiece and adversely affecting the automatic exposure meter reading.



Film Plane Indicator ③③

The film plane indicator (⊖) is engraved on the top deck just behind the ASA/ISO film speed ring ②⑧. It indicates the exact position of the film inside the camera and is used to measure the exact distance between the subject and film plane, such as in macro photography. The distance between the film plane and lens mounting flange ⑤ is exactly 46.5mm.



Infrared Focusing Index ②③

When you use infrared film, the plane of sharpest focus is slightly farther away than that in visible-light photography. To compensate for this shift in focus, most lenses have an infrared focusing index (a red dot or line) beside the distance index as a rule of thumb.

After focusing in the normal way, look at the lens and take note of the focused distance; then reset the focusing ring so that the desired distance is aligned with the infrared focusing index. Finally, attach the appropriate filter, such as the R60, etc., and take the shot.

- In infrared photography, the camera's built-in exposure meter will not give an accurate reading, so use the recommended settings supplied by the film manufacturer and, as insurance, bracket your shots.



Meter Coupling Lever ①③

This lever couples with the lens' meter coupling ridge ②⑩ on the aperture ring to perform full-aperture metering. Lenses whose aperture ring doesn't couple with this lever can not be used. For the following lenses, stop-down exposure measurement must be performed.

For lenses or accessories without automatic diaphragms

When a PC-Nikkor lens or bellows attachment is used, focusing should be done with the lens wide open while exposure measurement and shooting must be done with the lens stopped down.

- With a PC-Nikkor, the correct exposure must be determined on manual before shifting the lens.

For fixed-aperture lenses, photomicrography, or astrophotography

Since the aperture is fixed when using Reflex-Nikkor lenses, or in photomicrography or telescopic photography, it is impossible to change the exposure by varying the aperture. So, on auto, take the shot by simply depressing the shutter release button. On manual, turn the shutter speed/mode selector dial until the correct exposure is obtained. If the scene is too bright to obtain correct exposure, use an ND filter.

TECHNICAL INFORMATION

Relationship Between Shutter Speed and Aperture

Shutter speed (sec.)	1/1000	1/500	1/250	1/125	1/60	1/30	1/15	1/8
Aperture (f-number)	1.4	2	2.8	4	5.6	8	11	16

The amount of light reaching the film is determined by the combination of shutter speed and lens aperture. A shutter speed of 1/125sec. lets in twice as much light as a setting of 1/250sec. and only half as much light as 1/60sec. Likewise, an aperture setting of f/11 lets in twice as much light as f/16, and half as much as f/8. Thus, if the correct exposure for a particular picture-taking situation is 1/500sec. at f/2, then 1/250sec. at f/2.8 or 1/1000sec. at f/1.4 will give the same exposure.

The table above is an example showing the inter-relationship between shutter speed and aperture. Each combination produces the correct exposure but the effects in the pictures are quite different. The best combination will depend on the results you want. Fast shutter speeds freeze motion while slow speeds produce a deliberate blur. Also, small apertures give greater depth of field, while large apertures restrict the zone of sharp focus to the main subject. (Refer to page 34 for details on depth of field.)

To prevent the picture blur due to camera shake that is likely at slow shutter speeds, it's recommended that you select a shutter speed which is never slower than the reciprocal of the focal length of the lens in use. For example, when using a normal 50mm lens, select a speed no slower than 1/60sec. (the closest number to 1/50). For a 200mm telephoto, use no less than 1/250sec., and so forth.

- *The FG-20's audible warning is based on the normal 50mm lens, the standard and most popular focal length in 35mm SLR photography.*



Stop action

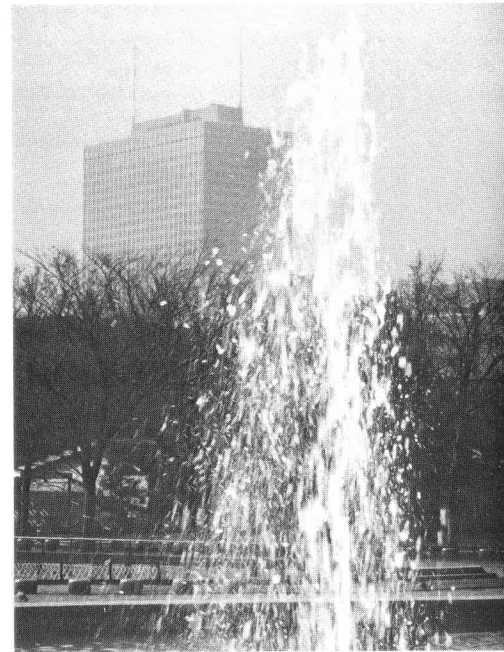

Subject motion blur

— TECHNICAL INFORMATION — continued

Depth of Field

When you shoot at a certain aperture and focusing distance, you will find that not only the main subject but also objects within a certain range in front of and behind it will be sharp in the final photograph. This "in-focus zone" is known as depth of field. Objects beyond this range become increasingly out of focus. When this zone of sharpness is large, the depth of field is said to be deep; when it is small, the depth of field is said to be shallow.

The following is true of depth of field:

1. The smaller the shooting aperture (i.e., the larger the numerical f-number), the deeper the depth of field; the larger the aperture, the shallower the depth of field.
2. The farther away the subject is from the lens, the deeper the depth of field becomes; the closer to the lens, the shallower the depth of field.
3. The longer the focal length of a lens, the shallower the depth of field; the shorter the focal length, the deeper the depth of field.
4. There is greater depth of field behind the main subject than in front of it.

The depth of field at each aperture is indicated on the lens by a set of color-coded lines ⑫ (corresponding to the colors of the f-numbers ⑲ on the aperture ring ⑧) which are used in conjunction with the distance scale ⑩ on the focusing ring ⑨. The range is indicated by the distance between the lines.



Lens set at f/2



Lens set at f/16

EV Range of the Camera

What is EV?

Exposure value (EV) is a number representing the available combinations of shutter speed and aperture that give the same exposure when the scene brightness and ASA/ISO remain the same.

At ASA/ISO 100, the combination of a one-second shutter speed and an aperture of f/1.4 is defined as EV 1. If the lens diaphragm is stopped down by one full f/stop or the shutter speed is one step faster, the EV increases by one; if the aperture is one full f/stop wider or the shutter speed is one step slower, EV decreases by one. Using ASA/ISO 100 as an example, 1 sec. at f/2 represents EV 2, 1 sec. at f/5.6 represents EV 5, while 1/125 sec. at f/5.6 represents EV 12. Because the exposure is the same, 1/30 sec. at f/11 and 1/1000 sec. at f/2 are also EV 12.

EV range

The camera's meter may be used only within the meter's EV range which determines the possible combinations of aperture and shutter speed, depending on the film speed in use. For example, at ASA/ISO 100, the FG-20's metering range is from EV 1 to EV 18 with an f/1.4 lens.

Exposure Compensation In the manual mode

There are two other situations in which it is difficult to get the correct exposure even with the use of the exposure compensation button **16**. They are (1) a front-lit scene where the main subject is off-center and is much brighter than the background and (2) a strongly backlit indoor subject which usually requires more than +2 EV exposure compensation. Therefore, to get the correct exposure, set the FG-20 to the manual mode and follow this procedure:

1. For front-lit subjects, just center the main subject. For backlit ones, you should move in close until it fills up the frame. (When taking a close-up meter reading, be careful not to cast a shadow with your own body or the camera.)
2. Depress the shutter release button **39** halfway to turn on the meter and manually adjust the shutter speed and/or aperture for correct exposure.
3. Recompose the scene as you like and take the picture.



TECHNICAL INFORMATION—continued

Duplication Work and Photomicrography

In copy work, slide duplication, and photomicrography, you must make exposure compensation because these types of photography represent unusual contrast situations. The table at the right shows the relationship between specific types of photos and the proper exposure. Since these suggestions are only intended as a guide, you should experiment until you get good results.

- *Since color slide film has narrow exposure latitude, it is advisable to bracket your exposures, keeping the following in mind:*

Increase the exposure by one stop for light-toned subjects

Decrease the exposure by one stop for dark-toned subjects

- *When using microfilm for duplication work, it is better to determine the exposure after experimentation. This is true because microfilm has very narrow exposure latitude; also the results are easily affected by the film emulsion number or the conditions under which the film is developed.*

- *It is advisable to use a cable release to eliminate camera vibration.*

- *To avoid vibration, you can make the exposure by turning the illumination on and off.*

	Subject	Method of exposure measurement	Exposure compensation	Required accessories	Remarks
Copy work	Photographs and pictures with continuous gradation	Full-aperture or stop-down	Compensation not necessary	Micro-Nikkor 55mm f/2.8; Cable release	For high-contrast subjects, the use of an 18% reflectance gray card in determining exposure is recommended. With the card, no exposure compensation is required regardless of whether the background is black or white.
	Documents and drawings of high contrast		Approx. +1 to +2 stops for black letters on white background; approx. -1/2 to -1 stop for white letters on black background.		
Slide duplication	Slide with continuous gradation	Stop-down	Approx. +1 to +2 stops	Micro-Nikkor 55mm f/2.8; Nikon Slide Copying Adapter PS-6; Nikon Bellows Focusing Attachment PB-6; Cable release	When using Nikon Slide Copying Adapter PS-6, set the flood lamp 30cm away from its opal plate.
	Slide of documents and drawings		Approx. +1-1/2 to +2-1/2 stops for black letters on white background 0 to approx. -1/2 stop for white letters on black background		
Photomicrography	Prepared specimen	Stop-down	Approx. +1 stop	Microflex PFX	Generally, results come out better with more exposure in photomicrography. The compensation value on the left is only a guide; determine the compensation value by test shooting.

+ : more exposure - : less exposure

Flash Photography

An electronic flash unit is convenient not only for night and dim-light shooting but also as a supplementary light to fill in the shadows in daylight. Daylight fill-in flash is especially effective when shooting outdoor subjects which are backlit or in motion.

The accessory shoe ④ of the FG-20 allows direct mounting of the Nikon Speedlight SB-19, SB-E, SB-15, SB-16B or other electronic flash units having a standard ISO-type mounting foot. Other flash units may be mounted by using a flash unit coupler (see table on page 42).

The FG-20 features an X-sync contact only, allowing electronic flash units to be synchronized at a speed of 1/90sec. or slower. To prevent mistakes, the camera also offers automatic switchover of the shutter speed for proper synchronization with the SB-19, SB-E, SB-15, SB-16B, etc., as shown in the table on next page. For creative fill-in flash effects, you can set the speed manually to 1/60sec. or below and the shutter fires at the speed you set.

- **The use of other manufacturers' flash units, even with the same ISO-type mounting foot, may cause abnormalities in shutter speed precision. Units having a high voltage synchro circuit may also cause damage to the camera's IC circuitry.**
- *When using a special electronic flash unit that has provision for time lag, adjust the shutter speed down to 1/60sec. or slower according to the time lag.*

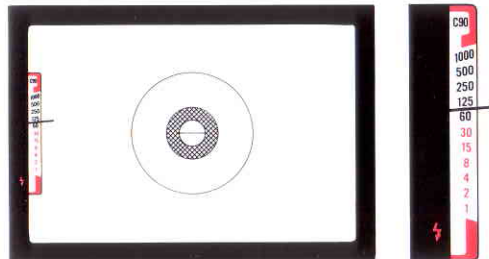

Ready-light indication in the viewfinder

When the Nikon FG-20 is used with the Nikon Speedlight SB-19, SB-E, SB-15, SB-16B, etc., the FG-20's ready-light (thunderbolt mark) in the viewfinder lights up when the flash is fully recycled. Thanks to this feature, you can tell when the flash is ready to fire without taking your eye away from the viewfinder.

Relationship between the camera's meter, ready-light indication and shutter speed

Shutter speed/ shooting mode selector dial setting	Camera's exposure meter			
	On		Off	
	Ready-light	Actual shutter speed (sec.)	Ready-light	Actual shutter speed (sec.)
A, (1) *	lights up	1/90	does not light up	—
1/1000— 1/125 sec.	lights up	1/90	does not light up	—
1/60—1 sec.	lights up	as set	does not light up	—
M90, B	—	—	lights up	as set

* Because the automatic exposure modes are cancelled as soon as the flash unit is turned on, you should determine the proper aperture beforehand.

TECHNICAL INFORMATION—continued

Nikon FG-20/Speedlight combination chart

Speedlight	Connection	Camera's ready-light indication	Shutter speed automatically switched to 1/90 sec.	Usable flash modes
SB-19	direct	provided	yes	auto*
SB-18	direct	provided	yes	manual
SB-17	Via AS-6 coupler	provided	yes	auto, manual, MD
SB-16A	Via AS-6 coupler	provided	yes	auto, manual, MD
SB-16B	direct	provided	yes	auto, manual, MD
SB-15	direct	provided	yes	auto, manual, MD
SB-11/14	Via SC-13 sensor cord	provided	yes	auto, manual
SB-12	Via AS-6 coupler	provided	yes	manual
SB-10	direct	provided	yes	auto, manual
SB-7E	Via AS-2 coupler	not provided	no	auto
SB-E	direct	provided	yes	auto*

* Full output of the flash is available when the FG-20 is set at M90 or B.

Nikon Speedlight SB-19

Compact and easy to use, the Nikon Speedlight SB-19 attaches to the camera's accessory shoe [Ⓢ] for automatic flash photography in dim light or outside at night. With the FG-20 left on auto, the shutter speed is automatically switched to the proper synchronization speed of 1/90sec. as soon as the flash unit is turned on. Then when the flash is recycled, the ready-light inside the camera's viewfinder comes on to let you know when you can take the next shot. It features a guide number of 20 (ASA/ISO 100 and meters) or 32 (ASA/ISO 25 and feet) and offers a wide choice of shooting apertures from f/2 to f/11 with ASA/ISO 100 film.



Nikon Motor Drive MD-14 and MD-E

For fast-moving subjects, attach the Motor Drive MD-14 and you can shoot up to 3.2 frames per second (fps) at the high speed setting or 2fps at the low speed setting. To take pictures, just push the FG-20's shutter release button  and automatically the film is wound to the next frame, so you never have to take your eye away from the viewfinder. One-frame-at-a-time picture taking is also possible.

The FG-20 also accepts the compact, lightweight Motor Drive MD-E for 2 fps shooting.



MD-14

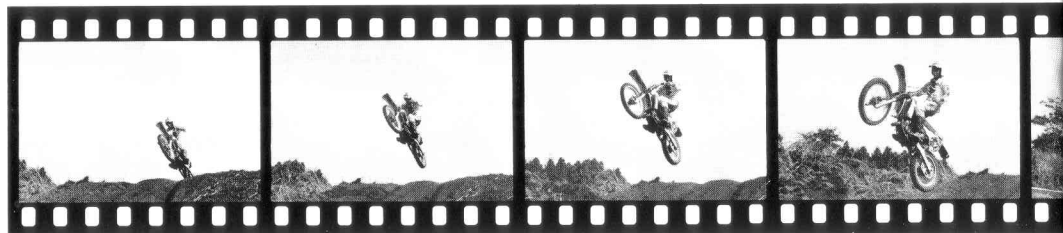

For shooting subjects which are located closer than the closest possible focusing distance of the lens, Nikon offers a wide variety of close-up equipment.

Close-Up Attachment Lenses Nos. 0, 1, 2, 3T, 4T, 5T, and 6T. These lenses screw into the front of the lens just like filters to magnify the image. Exposure metering can still be done at full aperture without compensation.

Auto Extension Rings PK-11, PK-12, and PK-13. These rings fit between the lens and camera body. Used singly or in combination, exposure determination is done at full aperture with all AI-type lenses.

Bellows Attachment PB-6. The PB-6 is also attached between the lens and camera body. Exposure is determined by the stop-down method. The beauty of this accessory is that you can change magnifications continuously by extending or contracting the bellows.

Micro-Nikkor 55mm f/2.8, 105mm f/2.8, and 200mm f/4 IF lenses. These specially designed lenses for close-up photography offer continuous focusing from infinity down to 1/2X lifesize.



Micro-Nikkors

Bellows Attachment PB-6



Auto Extension Rings



Close-Up Lenses

Nikon filters allow you to balance the light to match your film or to create interesting artistic effects. Nikon filters come in the screw-in, drop-in, and bayonet-mounting types. With the Nikon FG-20, the filter factor can be ignored except in the case of the R60. When using the R60 in tungsten lighting, give one-stop additional exposure.

- For lens protection, the L39 or L37C is recommended.
- When shooting a backlit subject or if there's a bright light source in the frame, a ghost image is likely to result when using a filter. In this case, you should take the picture without a filter.

These are recommended to prevent light coming in from the side from entering the lens and causing ghost images and flare. Four types are available to match various Nikkor/Nikon Series E lenses: snap-on, screw-in, slip-on, or telescopic which are already incorporated into the lens.



Type	Filter designation	Filter factor		Screw-in type (mm)							Drop-in type (Series IX)	Bayonet-mount type			
		Daylight	Tungsten light	39	52	62	72	95	122	160					
For Both Color and Black-and-White Film	Skylight	L1BC	1	•	•	•	•	•	•	•	•	•	•	•	
	Ultraviolet	L37C	1	•	•	•	•	•	•	•	•	•	•	•	
For Black-and-White Film	Ultraviolet	L39	1	•	•	•	•	•	•	•	•	•	•	•	
	Yellow	Light	Y44	1.5 (1/2)	1	•	•	•	•	•	•	•	•	•	•
		Medium	Y48	1.7 (2/3)	1.2 (1/2)	•	•	•	•	•	•	•	•	•	•
		Deep	Y52	2 (1)	1.4 (1/2)	•	•	•	•	•	•	•	•	•	•
	Orange	O56	3.5 (1 1/4)	2 (1)	•	•	•	•	•	•	•	•	•	•	
	Red	R60	8 (3)	5 (2 1/2)	•	•	•	•	•	•	•	•	•	•	
	Green	Light	X0	2 (1)	1.7 (2/3)	•	•	•	•	•	•	•	•	•	•
		Deep	X1	5 (2 1/2)	3.5 (1 1/4)	•	•	•	•	•	•	•	•	•	•
For Both Color and Black-and-White Film	Soft filters	No. 1	1	•	•	•	•	•	•	•	•	•	•	•	
		No. 2	1	•	•	•	•	•	•	•	•	•	•	•	
	Polarizing	Polar	2-4 (1-2)	•	•	•	•	•	•	•	•	•	•	•	
	Neutral Density	ND2X	2 (1)	•	•	•	•	•	•	•	•	•	•	•	
		ND4X	4 (2)	•	•	•	•	•	•	•	•	•	•	•	
ND8X		8 (3)	•	•	•	•	•	•	•	•	•	•	•		
ND400X	400 (8.3)	•	•	•	•	•	•	•	•	•	•	•			
For Color Film	Amber	Light	A2	1.2 (1/2)	•	•	•	•	•	•	•	•	•	•	
		Deep	A12	2 (1)	•	•	•	•	•	•	•	•	•	•	
	Blue	Light	B2	1.2 (1/2)	•	•	•	•	•	•	•	•	•	•	
		Deep	B8	1.6 (1/2)	•	•	•	•	•	•	•	•	•	•	
		B12	2.2 (1 1/4)	•	•	•	•	•	•	•	•	•	•		

() indicates increase in 1/stop.

To correct both near- and far-sightedness, nine lenses are available from -5 to +3 diopters. These values are derived from the dioptry of the finder plus that of the correction lens.

By helping to block stray light from entering the eyepiece (35), this improves the apparent brightness and contrast of the viewfinder image and facilitates focusing. Attaches directly to the viewfinder or eyepiece correction lens' frame.

Used when attaching the Magnifier DG-2. Be sure to lift the adapter before opening the camera back (47)

In cold weather, it's recommended that you use the Anti-Cold Battery Pack DB-2, which accepts two AA-type batteries, as an alternative power supply to the batteries inside the camera body. Simply connect the DB-2 to the camera body, then slip the battery pack inside your pocket or coat to keep it warm. This assures that the camera's metering system will function even in cold temperatures.

The screw-in type AR-3 provides vibration-free shutter release.

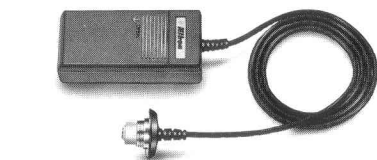
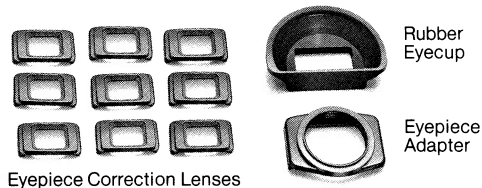

Two semi-soft cases, the CF-32 and CF-33 are available. The CF-32 accommodates the FG-20 with a 50mm f/1.4 or smaller lens attached, while the CF-33 is for use with the Series E 36-72mm f/3.5 or smaller lenses. The CF-18A, front flap, is also available for use with all lenses up to the Zoom-Nikkor 25-50mm f/4, Zoom-Nikkor 35-70mm f/3.5 or Zoom-Nikkor 35-105mm f/3.5-f/4.5.

Available are the leather neckstrap AN-1 (black), webbed nylon neckstraps AN-4Y (yellow) and AN-4B (black), and wider webbed nylon neckstraps AN-6Y (yellow) and AN-6W (wine-red).



CF-32

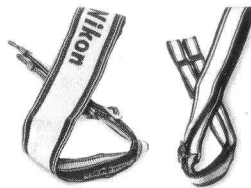

AN-6Y

AN-4Y

- Keep batteries away from infants and small children. In case a battery is accidentally swallowed, call a doctor immediately as the material inside the batteries may be fatal.
- Battery power falls off in extremely cold temperatures and this may cause the camera to cease to operate. In this situation, use new batteries and protect the camera body from the cold. Note that battery power will be recovered as soon as the temperature becomes normal.
- When not using the camera for a long period of time, take the batteries out and store them in a cool (below 20°C), dry place. Should the batteries be left in the battery chamber for a long period of time, insufficient contact may occur due to battery contamination. Thus, it is good practice to periodically clean the batteries and the contact section in the battery chamber with a soft cloth. If the battery chamber is stained by a leaking battery, remove the batteries at once and clean the chamber.
- Never mix new and old batteries or batteries of different makes.
- Always check battery power before every shooting session. It is a good idea to have spare batteries on hand during a lengthy shooting assignment.
- Never disassemble batteries or dispose of them by burning.
- In normal use, a battery's lifespan is about one year. The battery packed with this camera, however, is for test purposes only so its lifespan may be shorter than usual.

TIPS ON CAMERA CARE

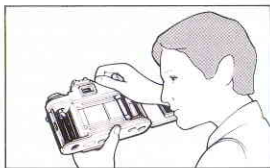

- Before using the camera, it is a good practice to check it thoroughly first.



- Never touch the reflex mirror ⑥ or the focusing screen, to prevent them from becoming scratched. Remove dust with a blower brush.

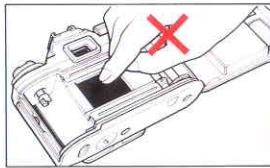

- Do not touch the shutter curtains ③④

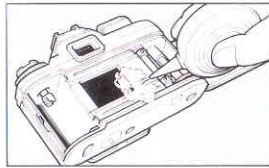

- Clean metallic parts with a blower brush or with a soft dry cloth.

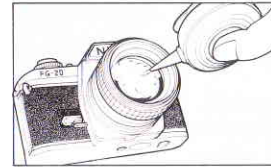

- Clean glass surfaces such as the lens or the finder eyepiece ③⑤ with a blower brush. Gently wipe dirt, smudges, or fingerprints with soft cotton moistened with a small amount of absolute alcohol.

Caution: Please note that the use of a spray-gun type blower to clean the lens may cause possible damage to the glass (especially when ED glass is used for the front lens element), by suddenly lowering the temperature on the lens surface. To avoid damage, hold the blower upright, keep its nozzle more than 30cm away from the lens surface and move the nozzle around so that the stream of air is not concentrated in one spot.

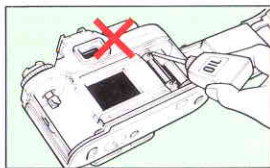

- Generally, the camera does not need lubrication.

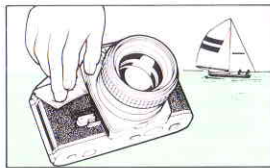

- If the camera body is exposed to rain or mist, wipe moisture gently with a soft cloth and dry the camera. After using the camera near salt water, wipe it with a cloth moistened with pure water to remove possible traces of salt.



- If the inside of the camera body accidentally gets wet, its internal precision parts may get rusty. Take the camera right away to the nearest authorized Nikon dealer for a checkup, which may require repair payment.

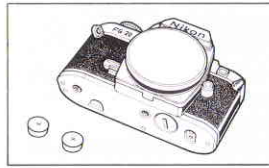

- When not using the camera for a long time, take out the batteries and store the camera away from high temperature, high humidity, naphthalene, or camphor.

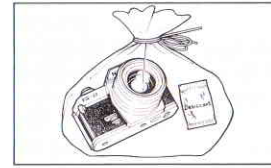

- In a humid environment, it is best to store the camera in a vinyl bag with a desiccant to keep out dust, moisture and salt.



- Note that storing leather cases in a vinyl bag may cause the leather to deteriorate, so exercise due care.

Type of camera	35 mm single-lens reflex
Picture format	24 mm × 36 mm (standard 35mm film format)
Lens mount	Nikon bayonet mount
Lenses	More than 60 Nikkor and Nikon Series E lenses available
Shutter	Electronically-controlled vertical-travel, metal focal plane shutter
Shutter speeds	Stepless speeds from 1 to 1/1000sec. in automatic exposure mode; discrete speeds from 1 to 1/1000sec. in manual mode; mechanically controlled M90 (1/90sec.) and B (bulb) settings available
Viewfinder	Fixed eyelevel pentaprism type; 0.86X magnification with 50mm lens set at infinity; 92% frame coverage
Focusing screen	Matte/Fresnel focusing screen with central split-image range-finder spot and microprism collar (Nikon Type K clear-matte screen)
Exposure control system	Aperture-priority automatic exposure with manual override and backup mechanical control; through-the-lens full aperture centerweighted metering

Audible warning	Available when shutter speed/mode selector dial is set at (M) ; "beep-beep" warning sound activated as soon as shutter release button is depressed halfway when shutter speed is around 1/30sec. or below or when meter needle is in over- or underexposure warning zone
Metering range	EV 1 to EV 18 at ASA/ISO 100 with 50mm f/1.4 lens
Exposure compensation	Approx. +2 EV exposure compensation possible by depressing the exposure compensation button
Film speed range	ASA/ISO 25 to 3200
Film advance lever	Wound in single stroke or series of strokes with 144° winding angle
Automatic film advance	Possible with optional Motor Drive MD-14 or MD-E
Frame counter	Additive type, self-resetting; for blank exposures before frame 1, shutter fires at 1/90sec. on auto or at any shutter speed/mode selector dial setting on manual

Film rewind	Via folding crank and rewind button in baseplate
Self-timer	Approx. 10sec. delayed exposure
Reflex mirror	Automatic instant-return type
Camera back	Pops open when film rewind knob is pulled up; memo holder provided
Accessory shoe	Standard ISO-type
Flash synchronization	Speeds of 1/90sec. or slower with electronic flash; with Nikon dedicated flash unit, flash sync automatically set to 1/90sec. when camera is set at either automatic exposure mode or when shutter speed/mode selector dial is set at 1/125 or higher in manual mode; at slower speeds on manual, shutter fires at speed set
Flash ready-light	Viewfinder thunderbolt mark lights up when Nikon dedicated flash unit is completely recycled
Meter ON/OFF switch	Exposure meter is switched on when shutter release button is depressed halfway; stays on for approx. 20sec. after finger is removed from button

Batteries	One 3V lithium battery (CR-1/3N), two 1.55V silver-oxide batteries (SR44) or two 1.5V alkaline-manganese batteries (LR44)
Dimensions	136mm(W) × 88mm(H) × 54mm(D)
Weight	Approx. 440g (body only)

The following lenses are usable with the Nikon FG-20:

- AI-S Nikkor lenses
- Nikon Series E lenses
- AI-Nikkor (including AI-modified Nikkor) lenses
- Zoom-Nikkor 180-600mm f/8 ED (No. 174167 or higher)*
- Zoom-Nikkor 200-600mm f/9.5 (No. 300491 or higher)*
- Zoom-Nikkor 360-1200mm f/11 ED (No. 174088 or higher)*
- Reflex-Nikkor 500mm f/8
- Reflex-Nikkor 1000mm f/11 (No. 143001 or higher)*
- Reflex-Nikkor 2000mm f/11 (No. 200311 or higher)*
- PC-Nikkor 28mm f/3.5
- PC-Nikkor 28mm f/4 (No. 180901 or higher)*
- PC-Nikkor 35mm f/2.8 (No. 851000 or lower or No. 906201 or higher)*
- Medical-Nikkor 120mm f/4 IF

Do not attempt to mount older Nikkor lenses which have not been AI-modified, as they might damage the camera.

- *Lenses with serial numbers other than those with an asterisk in the list at the left cannot be mounted on the FG-20 because they hit the camera's meter coupling lever ⑬. However, they can be used after modification. In addition, AI-modification of most non-AI lenses having a meter coupling shoe ⑲ is available. For further information concerning lens modification, please contact your local authorized Nikon dealer.*
- *The following lenses cannot be used on the FG-20 even if they are AI-modified:*
 - 28mm f/3.5 (No. 625611-999999)
 - 35mm f/1.4 (No. 385001-400000)
 - 55mm f/1.2 (No. 184711-400000)
- *If you use lenses other than those manufactured by Nikon, proper performance may not be obtained and they may even damage the camera.*

The Nikon FG-20 is an AI-type (Automatic Maximum Aperture Indexing) camera which performs full-aperture metering with AI-type lenses such as AI-S Nikkor, AI-Nikkor, and Series E lenses.

All AI-S and AI-Nikkor lenses can be identified by a meter coupling ridge ⑳ and a meter coupling shoe ⑲ with two holes in it (see illustration). In addition, the AI-S or AI symbol appears on the front cover on the instruction manual for each lens.

Nikon Series E lenses also have the same features as AI-Nikkor and AI-S Nikkor lenses, except they do not have a meter coupling shoe.

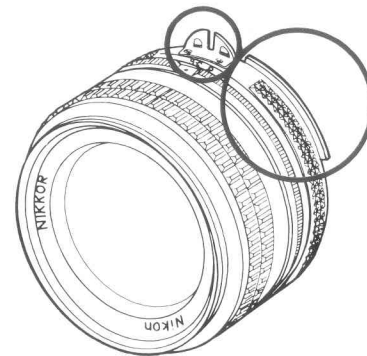

AI-Type Lens