

www.butkus.us

650-611

SUNPAK[®] AUTO 611

Thyristor

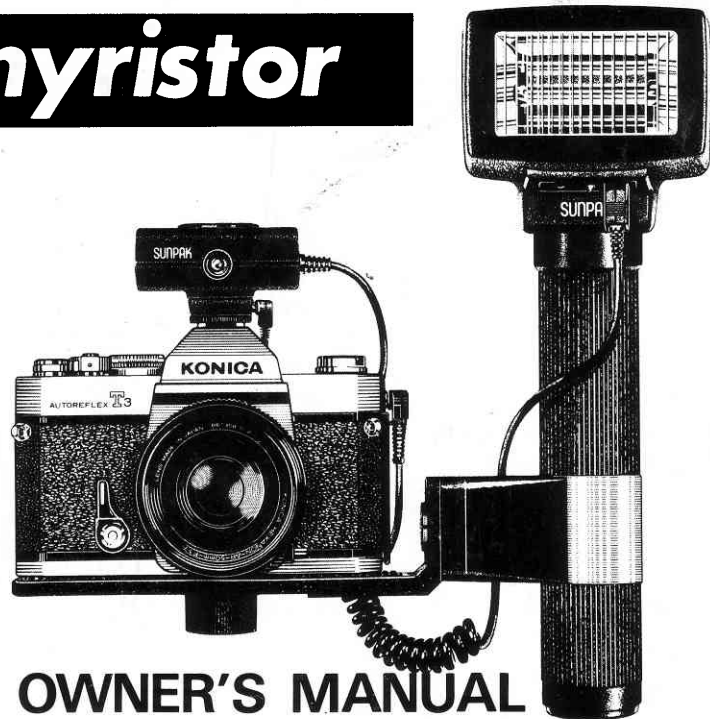

OWNER'S MANUAL

This manual is for reference and historical purposes, all rights reserved.

This page is copyright© by M. Butkus, NJ.

This page may not be sold or distributed without the expressed permission of the producer

I have no connection with any camera company

On-line camera manual library

This is the full text and images from the manual. This may take 3 full minutes for the PDF file to download.

If you find this manual useful, how about a donation of \$3 to: M. Butkus, 29 Lake Ave., High Bridge, NJ 08829-1701 and send your e-mail address so I can thank you. Most other places would charge you \$7.50 for a electronic copy or \$18.00 for a hard to read Xerox copy.

This will allow me to continue to buy new manuals and pay their shipping costs.

It'll make you feel better, won't it?

**If you use Pay Pal or wish to use your credit card,
click on the secure site on my main page.**

IMPORTANT SAFEGUARDS

When using your photographic equipment, basic safety precautions should always be followed, including the following:

1. Read and understand all instructions.
2. Close supervision is necessary when any appliance is used by or near children. Do not leave appliance unattended while in use.
3. Do not operate appliance if the appliance has been dropped or damaged—until it has been examined by a qualified serviceman.
4. To protect against electrical shock hazards, do not immerse this appliance in water or other liquids.
5. To avoid electric shock hazard, do not disassemble this appliance, but take it to a qualified serviceman when some service or repair work is required. Incorrect reassembly can cause electric shock hazard when the appliance is used subsequently.
6. Do not operate appliance with a damaged cord.
7. Do not let cord hang over edge of table or counter or touch hot surfaces.
8. If an extension cord is necessary, care should be taken to arrange the cord so that it will not be tripped over or pulled.
9. Always unplug appliances from electrical outlet when not in use. Never yank cord to pull plug from outlet. Grasp plug and pull to disconnect.

SAVE THESE INSTRUCTIONS

Introduction

The Sunpak Auto 611 Thyristor Flash is a remarkably versatile and sophisticated flash unit. It gives you ...

- **More Power.** Film-tested Guide Number of 160 for ASA 100 film, 80 for ASA 25 film.
- **More Control.** The Remote Silicon Photo Transistor Sensor measures the light reflected by your subject and automatically delivers the right amount of light for correct exposure — from nineteen inches to forty feet!
- **More Creativity.** Choose from any of four lens apertures in automatic operation — or any fractional or intermediate aperture, too. Or, choose up to eight apertures in manual mode!

- **More Versatility.** Bounce flash is automatic, because the sensitive Silicon sensor is always facing your subject. Or, choose instant, automatic off-camera flash.
- **More Flashes.** The energy-saving Thyristor circuitry gives you hundreds of extra flashes in automatic or manual operation — and provides ultra-fast recycling times as well. And the unique Nicad "Cluster" recharges completely in three hours.
- **More Pictoretaking Possibilities.** Dial the unique Power Ratio control to shoot at 1/2 power, 1/4 power ... all the way to an incredible 1/128th power. And you've opened up a whole new world of fill-in flash, macro flash, rapid-sequence flash, and more.

Because of its many unique features, operation of this flash is probably somewhat different from other electronic flash units you may have previously owned. For this reason, we recommend that, before actually taking pictures, you read through this Owner's Manual with your camera and flash unit before you. Then, as with any important new equipment, if possible expose a 'Test' roll of film to confirm that you are using your new equipment to best advantage. You'll be rewarded by superior flash pictures beginning with your first roll of film ... and for many, many years to come. Welcome ... to the Sunpak world of light!

Table of Contents

I.	Principal Parts of Sunpak Auto 611 Flash System	3
II.	Condensed Operating Instructions	4
III.	Selecting and Installing Power Source	5
IV.	Mounting Flash on Camera	8
V.	Automatic Operation	9
VI.	Automatic Operation: Bounce Lighting and Off-Camera Flash	11
VII.	Manual Operation: At Full Power	15
VIII.	Manual Operation: Using the Power Ratio Control to Select Different Lens Openings	16
IX.	Manual Operation: Syncho-Sun Photography (Fill-In Flash)	17
X.	Manual Operation: Creative Special-Effects Photography Through Controlled Flash Speeds	19
XI.	Manual Operation: Shooting at Controlled Recycling Times	20
XII.	Manual Operation: Choosing Guide Numbers	22
XIII.	Close-Up and Marco Photography With Your Auto 611	25
XIV.	Multiple Flash Operation	28
XV.	Using Filters for Special Effects	31
XVI.	Nicad Cluster Battery Charging	31
XVII.	Care of Your Electronic Flash	32
XVIII.	Major Accessories For The Sunpak Auto 611	33
XIX.	Technical Specifications of Sunpak Auto 611 Thristor Flash	35
XX.	About the Manufacturer	36

I) PRINCIPAL PARTS OF SUNPAK AUTO 611 FLASH SYSTEM

- 1) Flashtube Housing
- 2) Remote Sensor Outlet
- 3) Auxiliary Shutter Cord Outlet
- 4) Battery Chamber Lock
- 5) AC/510V Outlet
- 6) Manual Exposure Calculator Dial
- 7) Manual Power Ratio Dial
- 8) Auto/Manual Mode Selector
- 9) Battery/AC Selector (On/Off Switch)
- 10) Test (Open Flash) Button
- 11) Auto Signal Lamp
- 12) 100%-Power Ready Lamp
- 13) Remote Sensor Housing
- 14) Remote Sensor Flash Cord
- 15) Auto Exposure Control Dial
- 16) Silicon Photo Transistor Cell
- 17) Remote Sensor Shutter Cord
- 18) Remote Sensor Test Button
- 19) Auxiliary Shutter Cord
- 20) Tripod Mounting Socket
- 21) Dual-Voltage AC Adapter
- 22) Voltage Selector Switch
- 23) AC Flash Plug
- 24) Flash Grip
- 25) Flash Bracket Clamp
- 26) Encircling Ring of Clamp
- 27) Quick-Release Button
- 28) Lock Ring
- 29) Camera Mounting Bracket
- 30) Camera Retaining Ring

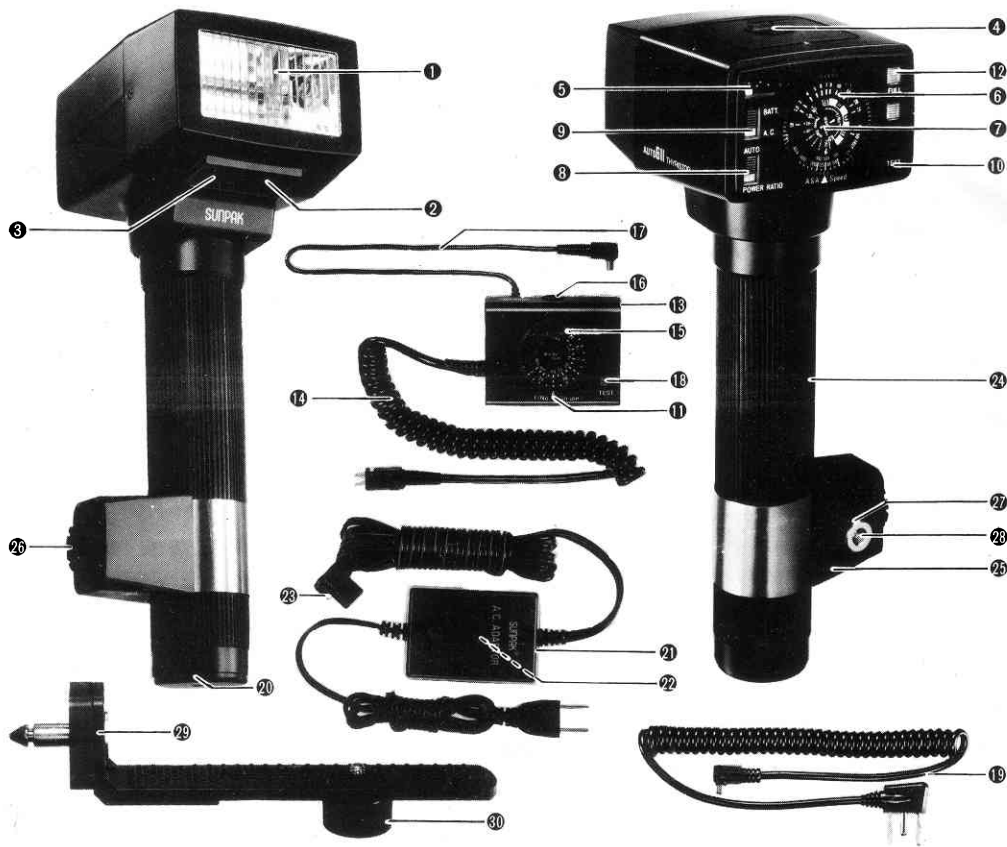

II) CONDENSED OPERATING INSTRUCTIONS

To use your Sunpak Auto 611 Thyristor Flash, here's all you have to do:

- 1) **Install Batteries** (p. 6). Lift off Battery Chamber cover and insert freshly-charged Sunpak Nicad Battery Cluster (or selected power source).
- 2) **Mount On Camera** (p. 8). Attach camera to bracket and bracket to flash clamp. Connect Remote Sensor to flash and camera. Set shutter to the fastest speed synchronized with electronic flash (p. 8).
* **Note:** Move Auto/Power Ratio Switch (on back) to Auto Position (red is visible).
- 3) **Select Lens Opening For Auto Operation** (p. 9). Move Auto Exposure Control Dial to desired f/stop and distance for film in use; set lens to this opening.
- 4) **Take The Picture!** (p. 10). Move switch on flash to 'Batt' (On) position; when the Auto Signal Lamp and 100% Green Ready Lamp glow, you're ready to take the picture!

To confirm that the subject is within the maximum distance range for correct exposure, aim flash towards subject and press the 'Test' button. The Auto Signal Lamp on Remote Sensor will "blink" immediately after this test flash when the subject is within computer range (p. 10).
Picture after picture — different subjects, different distances, different surroundings. All perfectly-exposed, automatically, with your Sunpak Auto 611 ...

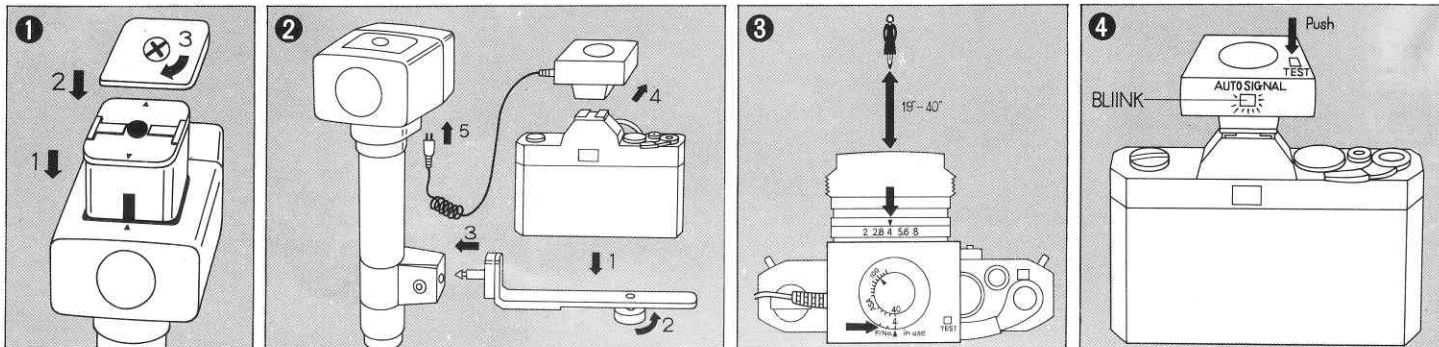

III) SELECTING AND INSTALLING POWER SOURCE

Your Sunpak Auto 611 flash accepts no less than five alternative power sources! Here are the major differences and advantages of each type.

Power Source Type	No. of Flashes*		Recycling Time Between Flashes*		Notes
	Full	1/128th power	1/128th power	Full	
Sunpak Nickel – Cadmium Battery Cluster (Type CL-1)		40~800	0.25~9.5 sec . . .		Gives maximum portability and convenience. Recharges fully in three hours externally.
4 'C' – Size Nickel – Cadmium Batteries (optional)		60~1200	0.25~9.5 sec . . .		Recharge externally in separate charger. Charge time varies according to battery and charger type.
Sunpak 510V Powerpak (optional) (Requires Eveready #497 battery or equivalent)		70~5000	0.25~3 sec . . .		Fastest recycling speed and greatest number of flashes of all battery types (see p. 21)
100–240V AC (adapter supplied)		Unlimited	0.25~30 sec . . .		Adjustable by owner for 100–120V or 200–240V current.
4 'C'–Size Alkaline Batteries (optional)					Recommended exclusively for emergency use due to longer recycling time with this battery style.

*All specifications are approximate.

Each Power Source installs quickly and easily. Here's how:

A) With Sunpak Nicad Battery Cluster*

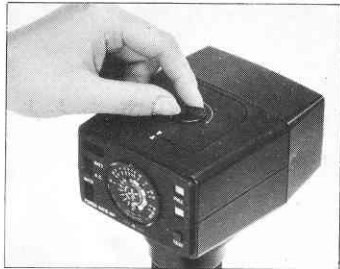

1) Twist Battery Chamber Lock counter-clockwise and lift off cover.



2) Insert Battery Cluster facing triangle marks of Battery Cluster and compartment.

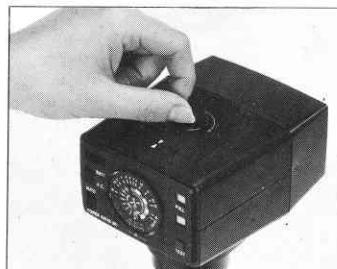

3) Replace Battery Chamber Cover and lock in place.

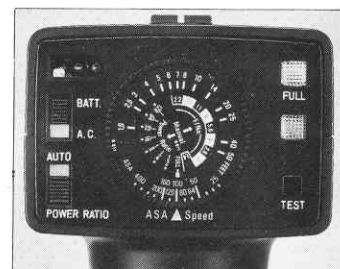

4) Move 'Battery/AC' Selector on rear of flash to 'Batt' position.

*Note: Newly-purchased nickel cadmium batteries and Clusters are usually shipped with a partial "charge". For best results, charge fully prior to extensive use (see page 32).

B) With 4 Nickel-Cadmium* or Alkaline C-Size Batteries

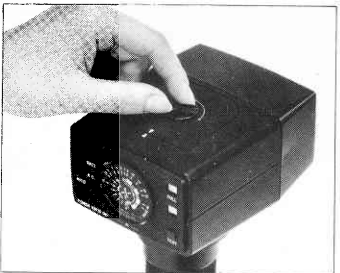

1) Twist Battery Chamber Lock counter-clockwise and lift off cover.

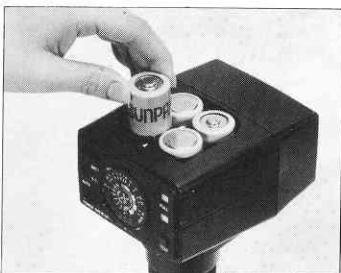

2) Insert four batteries as shown inside flash.

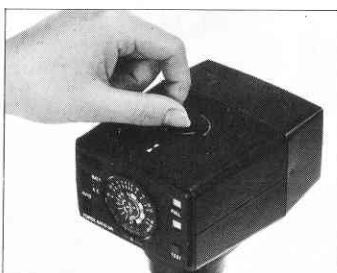

3) Replace Battery Chamber Cover and lock in place.

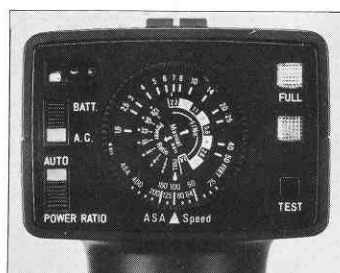

4) Move 'Battery/AC' Selector on rear of flash to 'Batt' position.

C) With Sunpak 510V Powerpak



- 1) Insert 510V battery into Powerpak as shown on Powerpak.

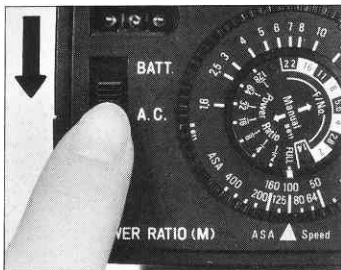

- 2) Move 'Battery/AC' Selector on rear of flash to 'AC' position.



- 3) Connect Power Cord to Powerpak (Screw-on) and flash (to socket above Battery/AC selector).



- 4) Move 'On/Off' switch of Powerpak to 'On' position.

D) With AC Current



- 1) Before plugging in, determine that AC Adapter is set for 100–120V operation when used in the United States, Canada, or other countries with this standard. If Adapter is not set for correct voltage, loosen the Phillips-head screw on back of adapter, re-set selector to correct voltage, and tighten screw securely. **Important:** if voltage selector is set incorrectly, damage to your flash and adapter may result.

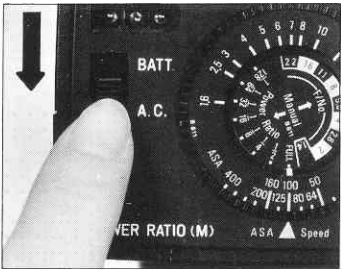

- 2) Move 'Battery/AC' selector on rear of flash to 'AC' position.

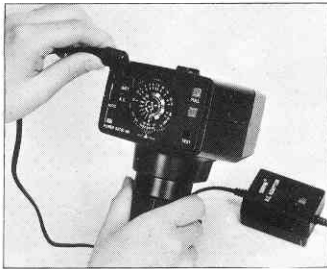

- 3) Plug female end of AC cord into flash outlet (above Battery/AC selector).

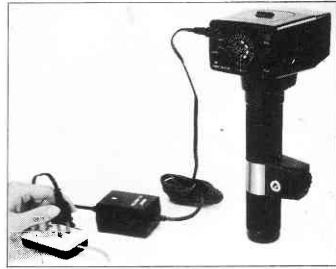

- 4) Plug other end of AC adapter into electrical outlet.

IV) MOUNTING FLASH ON CAMERA

Your flash unit has a quick-release mounting clamp attached to the flash grip (handle). This clamp accepts a snap-in bracket; your camera is secured to the bracket. As the bracket may be removed from the clamp with a one-touch action, set-up and disassembly of your equipment is quick and positive.

- 1) Turn Locking Button (silver) on clamp counter-clockwise fully.
- 2) Press Locking Button inwards firmly, and hold in place.
- 3) Slide silver end of bracket into center of clamp.
- 4) Release Locking Button. The bracket is now attached to the clamp. For ultimate security, you may additionally tighten the locking screw by turning it clockwise fully, this makes inadvertent separation of bracket and clamp impossible.

- 5) Press Camera Retaining Screw through opening at end of slot on bracket, and turn screw clockwise firmly until threaded portion of screw passes above bracket slot. Center the camera retaining screw under your camera's tripod socket, and tighten securely.
- 6) Set shutter speed to the fastest speed usable for electronic flash with your camera, provided that speed does not exceed 1/400th second. On single-lens reflex cameras with focal-plane shutters, this speed is usually 1/60th or 1/125th; cameras with in-the-lens shutters usually allow synchronization at speeds up to the maximum of 1/400th. Do not set shutter to a speed faster than 1/400th second, as this may cause under-exposure when the flash is used at maximum power. (If shutter has a switch marked 'M' and 'X', place at 'X' position.)

- 7) Slide Remote Sensor Housing on camera's

accessory shoe, and lock in place by turning knurled screw clockwise. Attach Remote Sensor Flash Cord to Remote Sensor Outlet of flash (under Flashtube Housing). For cameras with 'Hot' flash shoes, no further preparation is required. However, if your camera does not have a 'Hot' shoe, plug synchrocord to synchrocord receptacle (beside mounting foot) and plug the other end of synchrocord to camera's 'X' flash outlet.

***Note 1:** Should you desire to mount the flash on the **right** side of your camera, or raise or lower the flash handle within the clamp, this may be done by loosening the two Phillips-head screws inside the encircling ring of the clamp, then repositioning the encircling ring as desired. Be sure to tighten the screws again **fully** for maximum stability and correct lighting angle.

***Note 2:** If you desire to remove Sensor plug from receptacle for storage, push lock button toward reverse side of the plug while pulling to remove the Sensor plug. The construction is designed precisely to prevent loosening connection.

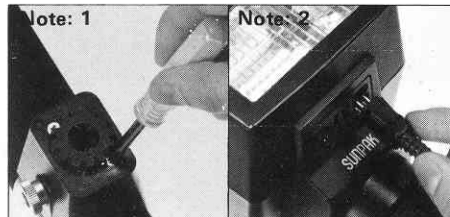
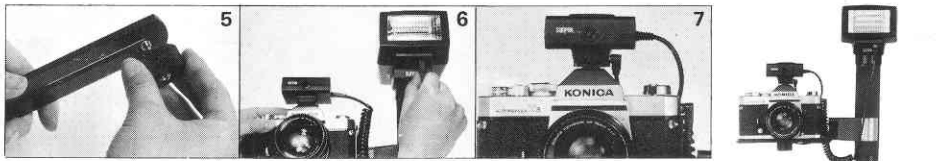
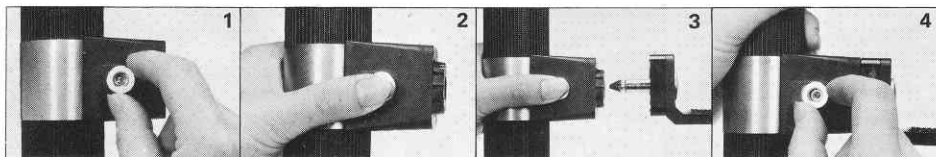

V) AUTOMATIC OPERATION

The sensitive Silicon Photo Transistor of your Auto 611 Remote Sensor measures the light reflected by your subject, and automatically controls the flash duration to assure correct exposure within a wide range of distances. It's easy to use:

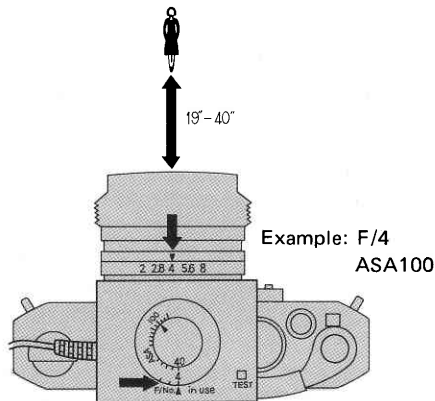
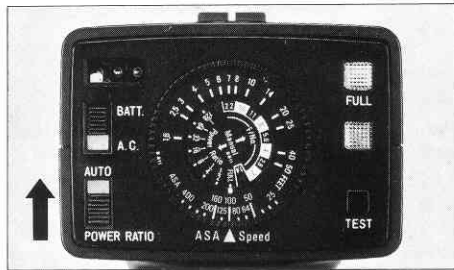

- 1) Move Auto/Power Ratio Mode Selector on back of flash to 'Auto' position.
 - 2) Rotate outer ring of Auto Exposure Sensor Dial until ASA film speed in use is shown by the red triangle (Example: ASA 100)
 - 3) Rotate entire calculator dial assembly until desired lens opening is indicated by white triangle. Set camera lens to this opening (f/number).
- * You will note that you may select **any** lens opening within a 4-stop range. For example, with ASA 100 film openings from f/4 to f/11 may be chosen. By using a **wider** lens opening you gain the ability of taking pictures at the greatest distance — up to 40 feet at maximum aperture. Choosing a **smaller** lens opening reduces the maximum distance range, and increases depth-of-field or the 'zone' of overall sharpness. You may even set this control to an **intermediate** or **fractional** lens opening (such as f/4.5 or f/6.3) to match the maximum aperture of a particular lens, or for any desired reason.

- * The **minimum** distance for correct **automatic** exposure is **19 inches**, regardless of the lens opening in use.

- * An interesting benefit of your flash's energy-saving (Thyristor) circuitry: by shooting at the **widest** possible lens opening (f/4 with ASA 100 film) you not only obtain the greatest distance range but also the greatest **number of flashes**, and fastest recycling times, in normal operation. Reason: at a given distance, less energy is required to light a subject at f/4 than at smaller apertures (f/5.6–f/22).
- * **Smaller** lens openings (f/8–f/22) provide greater 'depth-of-field' within their usable distance range (to 14 feet at minimum aperture). One good time to choose them is when you're taking pictures of children or sporting events, where it's hard to stay in focus because the subjects are usually moving. By shooting at smaller lens openings (f/8–f/11 with ASA 100 film) you'll generally get sharper pictures of moving subjects. This is also handy in dim light or with wide angle lenses, when precise focusing is somewhat harder than normal.

Take The Picture!

- 1) Move Battery/AC Selector (On/Off switch) on flash to appropriate position for power source in use. Within seconds, you'll notice the
- 2) 'Auto Signal' Lamp on Sensor will glow. This confirms that your flash is set for automatic operation. Then, the

- 3) Green 'Ready' Lamp will also glow, signaling that your flash is ready to fire at full (100%) power. Now, focus and ... **Take the Picture!** Your flash will **automatically** deliver the correct amount of light for correct exposure within the distance range indicated.

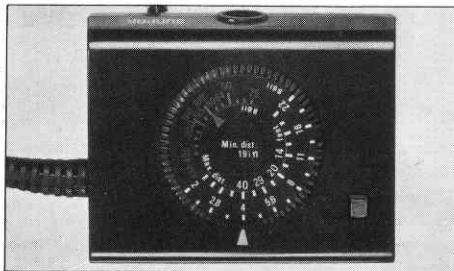
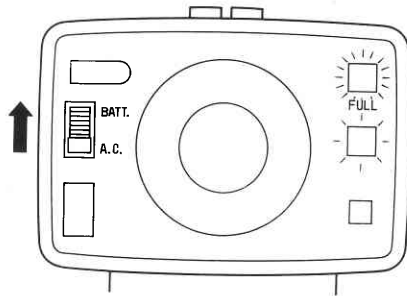

For Succeeding Exposures ...

Just wait until the green Ready Lamp comes on; make sure you're within the usable distance range for the lens opening in use ... and shoot!

To Verify Correct Exposure

Aim the flash towards the subject and press the 'Test' button. The flash will fire and, immediately afterwards, the Auto Signal Lamp will turn off, then quickly light again; when this occurs, the automatic exposure will be correct. If the Auto Signal Lamp does **not** go off, choose a wider lens opening, or move closer to your subject and repeat the verification test. It's a simple, highly accurate way of confirming that your picture will be perfectly exposed before you expose it!

More About Your 'Auto Signal' Lamp ...

The Auto Signal Lamp of your flash performs three valuable functions:

- 1) **Confirms Automatic Operation.** When the lamp lights, the flash is set for automatic operation. In manual operation, the lamp shuts off.
- 2) **Confirms That Subject Is Within Correct Maximum Distance Range.** By blinking after a test flash, the Auto Signal Lamp on Sensor shows that the flash has used less than its full power in automatic operation, and that unused energy is being stored. Thus, you

can be sure that the subject is within the maximum distance for correct exposure.

When a test flash is fired at the **maximum** subject distance, the flash must use all its energy to correctly light the subject. Accordingly, at the **limit** of the distance range selected, the flash will operate at full power and the Auto Signal Lamp may not 'blink'. Should this occur, your picture **will still be correctly exposed** so long as your subject is not at an appreciably greater distance than shown on the Auto Exposure Calculator Dial (example: 40 feet at maximum auto aperture).

- 3) **Signals Battery Depletion.** If the Auto Signal Lamp remains off for **one second or more** following a test flash, the batteries are weak and should be recharged (if Nickel-Cadmium type) or replaced (if Alkaline or 510V type).

* When you're done taking flash pictures, move the Battery/AC switch to 'Off' position; no energy is now being consumed. (Note: the Auto Signal and Ready Lamps may continue to glow for several minutes; this is O.K.)

VI) AUTOMATIC OPERATION

Bounce Lighting

Your Sunpak Auto 611 electronic flash allows soft, shadowless 'bounce' lighting to be used whenever desired. This advanced lighting technique beams the light off ceiling or wall, to spread a soft, diffused light evenly throughout the entire area. Bounce lighting is almost totally free of the shadows which often accompany direct lighting, making it particularly valuable for photography of people as well as finely-detailed close-up and macro subjects.

- 1) Loosen Locking Screw on Sunpak flash clamp by turning it counter-clockwise. Press Retaining Button inwards and hold it.
- 2) Pull out bracket from flash clamp, and rotate flash clockwise until desired angle is reached.
- 3) Press bracket in until it 'clicks' in place; tighten Locking Screw.

- * Since the Remote Sensor of your Sunpak Auto 611 is always facing the subject, bounce flash exposures are controlled automatically as indirect lighting. Generally, it is wise to pre-set your flash and lens for use at the widest available lens opening, as the extra distance traveled by the light — and the light absorbed by the ceiling — often diminish the light on the subject sharply.
- * Always take care that the 'bounce' surface (usually the ceiling) is of a white or neutral color. Surfaces with a different color will cause that color to mix with the light of the flash on the subject.

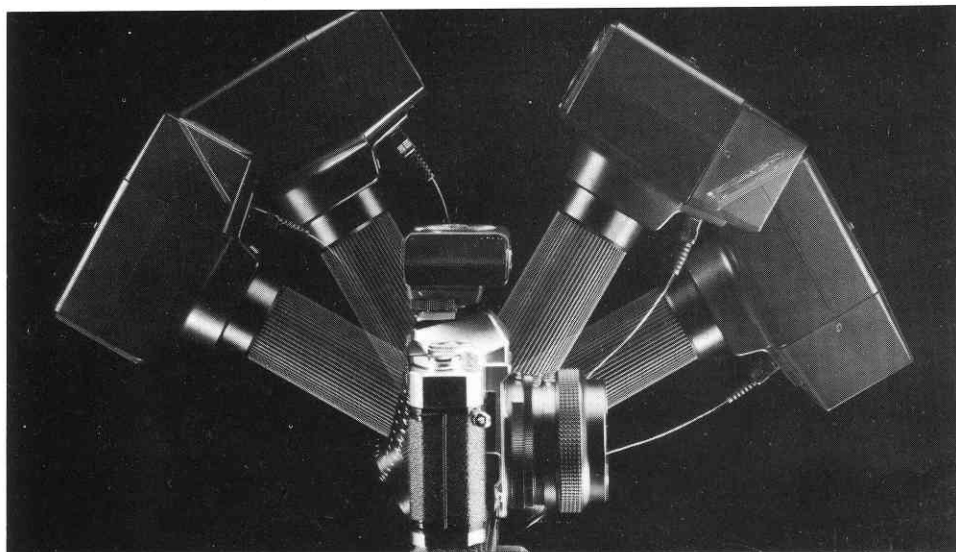

Note: For bounce flash with your camera held in vertical position, remove flash from bracket and loosen the Phillips-head screw inside Quick-Release Clamp. Rotate flash 'handle' so flash will aim upwards at desired angle, tighten screws firmly, and re-attach flash to bracket.

Tips For Better Bounce Pictures

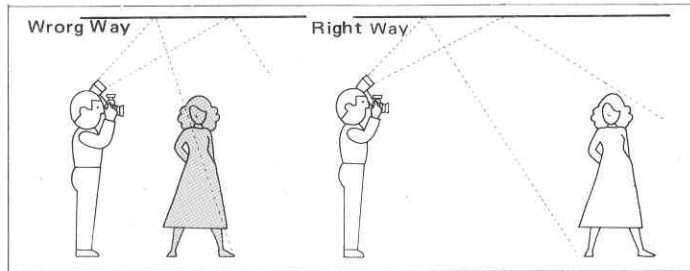

- * **Don't Stand Too Close to Your Subject.** Reason: the light will be reflected downwards at an angle so acute that no light (or very little light) can reach your subject's face. This can cause unpleasant-looking 'dark spots' under the subject's nose and eyes.

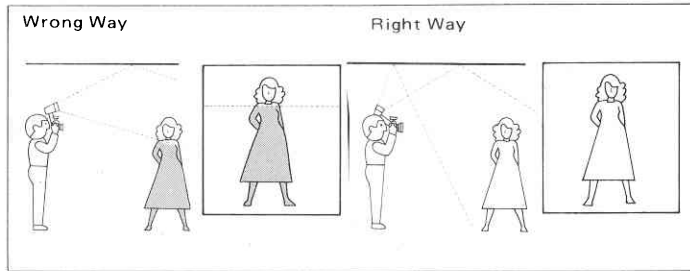

- * **Rotate flash sufficiently to prevent the subject or the background immediately behind the subject from receiving any portion of direct light from flash.**

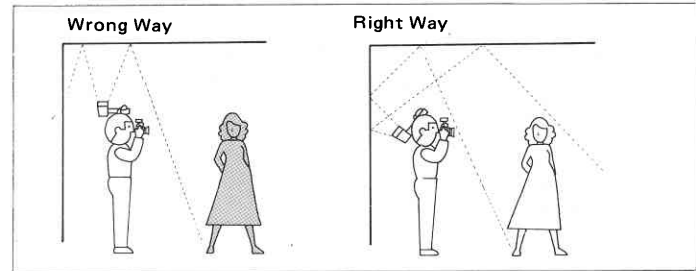

- * **In Small Rooms, Try Bouncing The Light Off The Wall Onto The Ceiling.** Provided it's a white-colored wall and ceiling, this technique gives much more even lighting than direct off-ceiling bounce where space is limited. Try it!

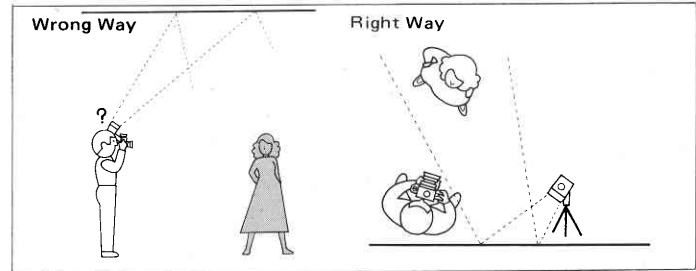

- * **Remember That You Can Bounce Off The Wall If The Ceiling's Too High.** There isn't any law that says bounce flash must be beamed off the ceiling! In many homes, a white-color wall makes an excellent reflective surface for bounce flash ... and, quite often, more light can reach the subject since the light does not have to travel as far. Try it! (Just press the Quick-Release Button and hand-hold the flash for the desired lighting angle.)

- * **Can't Find A Suitable Bounce Surface? Make One ...** If the wall or ceiling is any color other than white, your subject will show that color in the finished photograph. Solution: create your own bounce 'surface' ... possibly an ordinary piece of white cardboard held or taped in front of the flashtube housing, so that it reflects the flash light onto the subject.

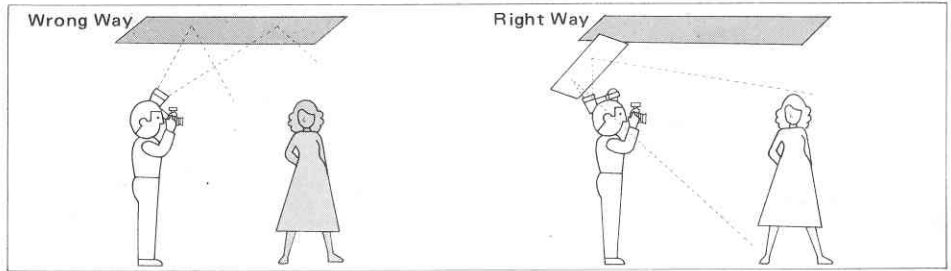

- * **In Close-Up Photography,** many excellent lighting effects can be achieved by using one or more pieces of white cardboard as reflective surfaces in bounce flash. The soft, diffused effect of 'bounce' light often reveals fascinating details of small objects.

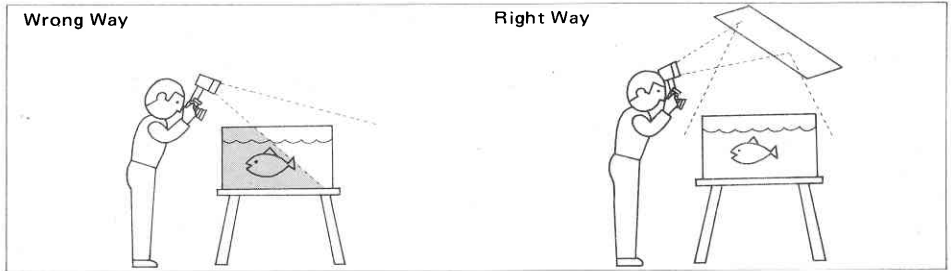

- * **For Extensive Use In Portrait And Child Photography,** many photographers prefer 'umbrella' lighting, created by bouncing the flash off a white or silvered umbrella. Check with your photo dealer for recommendations on umbrellas and lightstands if this approach interests you.

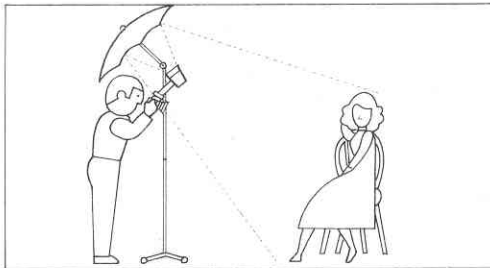

Off-Camera Flash

Off-Camera flash offers many of the benefits of bounce flash. In addition, it allows the full power of the flash to be used, thus permitting professional lighting effects (and smaller lens openings) irrespective of distance or ceiling reflection. It's easy to use:

- 1) Set flash to 'Auto' position, and adjust camera lens to f/number indicated by Auto Exposure Control Dial.
- 2) Focus on your subject. Turn Bracket Lock Ring counter-clockwise fully. Hold camera securely in right hand.
- 3) Press Quick-Release Button inwards, and lift flash away from bracket. Hold flash in left hand, as far away from your camera as possible; aim flash directly at subject.
- 4) Take the picture! Your flash will measure and deliver exactly the light required for your subject... and the highly directional lighting will provide excellent illumination. Since the flash is beamed towards your subject off the optical axis, shadows will be directed away from the subject – out of the picture area.

It's a basic professional lighting technique... made easy by your Sunpak's unique Quick-Release Flash Bracket!



VII) MANUAL OPERATION

At Full Power

In general, the sole advantage of manual operation at full power is the ability to take pictures at distances greater than 40 feet (beyond maximum 'Auto' range). Here's how:

- 1) Move Auto/Power Ratio Switch on back of flash to 'Power Ratio' position.
- 2) Move Power Ratio Dial on back of flash to 'Full' position.
- 3) Set ASA film speed in use opposite triangle. Focus, and read the camera-to-subject distance from your lens.

Find this distance on the Calculator Dial. Directly below this distance you'll see the lens opening for correct exposure. Set your lens to this opening ... and shoot.

* If desired, the Remote Sensor may be removed when using manual exposure at full to 1/128th power. After unplugging sensor, attach Auxiliary Shutter Cord (supplied) between Auxiliary Shutter Cord Outlet of flash and 'X' outlet of camera. While there is no practical benefit in removing the Remote Sensor, this procedure may be desired in situations where it is known in advance that the flash will be used exclusively in manual mode.



VIII) MANUAL OPERATION

Using The Power Ratio Control To Select Different Lens Openings

Your Sunpak Auto 611 electronic flash has the unique capability of variable light output, even when used in manual mode. This enables you to shoot at wider or smaller lens openings in manual mode for selective depth-of-field control and, as the nergy-saving thyristor circuitry continues to function, simultaneously shortens recycling times and provides greater numbers of flashes. Yet, this remarkable feature is extremely easy to use:

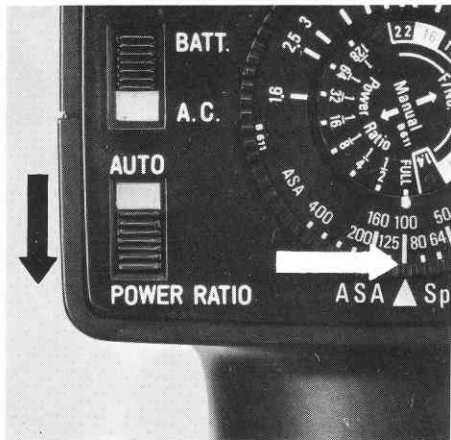

- 1) Move Auto/Power Ratio Mode Selector Switch on back of flash to 'Power Ratio' position. This disengages the auto computer circuit of your flash.
- 2) Move (outer) Calculator Dial to show correct ASA film speed. (example: ASA 100).
- 3) Focus as you normally do. Note the distance shown by the distance indicator on your lens. (example: 7 feet).
- 4) Now, simply move the Power Ratio Dial (in center of Calculator Dial) until the desired lens opening appears under the correct flash-to-subject distance (7 feet). With ASA 100 film at 7 feet from your subject, you can select any of **eight** different lens openings from $f/2$ (1/128th power) to $f/22$ (at full power). Set your lens to this opening. If an intermediate lens opening is indicated, simply set your Lens Aperture Ring. However, always move the Power Ratio Control Dial to marked position (such as Full, $\frac{1}{2}$, $\frac{1}{4}$, etc.) Do not set Power Ratio Dial to positions in between marked numbers. (Should this be done, the flash will operate at Full power and over-exposure may result.)
- 5) Shoot! Your Sunpak Auto 611 flash will deliver the correct volume of light for a perfectly exposed picture at the distance and lens opening selected.

- * **Wider** lens openings ($f/1.4$, $f/2$, $f/2.8$) give the least depth-of-field. This effect makes the background appear blurred, while the subject is recorded sharply.
- * **Smaller** lens openings ($f/11$, $f/16$, $f/22$) record more background and foreground objects sharply. Use smaller lens openings when you wish to show the surroundings clearly, or when your subject is hard to focus on precisely (example: children at play).

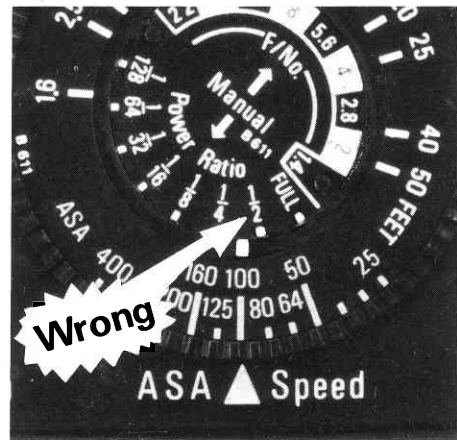

IX) MANUAL OPERATION

Synchro/Sun Photography (Fill-in Flash)

Your Sunpak Auto 611 electronic flash is of significant benefit even in outdoor photography. Example: bright day at the beach ... much too bright for your subject to face into the sun. So you turn her around, and shoot against the sunlight: a backlit shot. You even carefully take a close-up meter reading of her face, to insure that the exposure is based on the light on her face (relatively dim) and not the background light (extremely bright). While this technique will produce a well-exposed image of the subject, the background will be rendered far too light; the brightness values in the scene are beyond the ability of any film to record. Solution: Sunpak Auto 611 ... and its unique Power Ratio control.

- 1) With your camera's built-in exposure meter (or a separate meter), determine and set the correct lens opening for the **brightest part of the scene** when exposed at the fastest speed at which your camera synchronizes with electronic flash. (Automatic cameras of the shutter-priority type, such as Konica may be used in "Automatic" mode.)

Example: Set your camera's shutter to 1/125th second (or to whatever is the fastest speed synchronized for electronic flash so long as that speed does not exceed 1/400th second). Your meter indicates correct exposure for the brightest part of the scene — usually the background. Example: f/8: Set your lens to this opening.

- 2) Focus, and read the camera-to-subject distance in feet from your lens' distance scale. Example: 5 feet.
- 3) You have now determined the two required parameters for correct exposure — aperture and distance. Move Power Ratio Dial so that the required distance (5') appears above the required aperture (f/8). Your flash will now operate at the correct power ratio setting for perfectly-balanced fill-in flash.

Example: Where an aperture of f/8 is required at a distance of five feet, a "power ratio" of 1/16th is set for ASA 100 film.

- 4) Shoot! Your picture will be perfectly exposed, as the light of the flash on your subject is now balanced perfectly with the exposure required for the brightest part of the scene!

EXAMPLE Shutter speed: 1/125th second
Distance to subject: 5 feet
Film speed: ASA 100
Aperture: f/8



Full fill-in (1/16th power)

The technique described above provides equal brilliance on the subject and the brightest part of the overall scene. This effect is called "full" fill-in and gives excellent results with a majority of subjects.

- * Should you prefer a **less pronounced** fill-in effect (less light on subject), move the Power Ratio Control to the next **smallest**



position: for example, 1/32nd when 1/16th is indicated. Use this technique when your subject is in only slight shadow or is unusually light in complexion or appearance.

- * Alternatively, you may wish to employ a **more pronounced** fill-in flash effect when your subject is either dark in complexion or is in extremely heavy shadows and thus



much less well lit than the brightest part of the scene. This "extra" fill-in effect is achieved simply by dialing a Power Ratio one step **greater** than indicated — for example, 1/8th instead of 1/16th.

- * Experiment when possible, to determine the ratio most pleasing to you with subjects representative of your normal picture-taking.



X) MANUAL OPERATION

Creative Special-Effects Photography Through Controlled Flash Speeds

Your Sunpak Auto 611 Power Ratio control opens up a whole new world of photographic enjoyment ... with many important industrial and scientific benefits too. Because of this flash unit's unique electronic circuitry, you can actually control the duration (speed) of each flash. In automatic operation, your flash will light for a period ranging from 1/400th second to as fast as 1/50,000th second (depending on flash-to-subject distance). Yet in manual operation, the unique Power Ratio control allows you to control the flash speed every time **regardless of flash-to-subject distance!** At "Full" power, flash speed is approximately 1/400th second; at 1/2 power, about 1/800th second... and so on; at 1/128th power, the flash speed shortens to an incredible 1/50,000th second — fast enough to "freeze" virtually any moving object!

Scientists call it 'Motion-Analysis Study'. What is it? Pictures of objects in motion, photographed at high speed to reveal that motion to the eye. Perhaps a stone being dropped into a bowl of water. Or a balloon being burst. Or an egg, dropped on a counter top. A Karate expert, breaking a bottle. A Golfer's swing, a Bowler's "delivery"... any of a thousand-and-one things in everyday life that we look at... but never really see. Now, we can:

- 1) Set up your camera with flash attached in a convenient location — preferably, mounted on a sturdy tripod.
- 2) Determine and set the correct lens opening for the power ratio selected (see chart, p. 21).
- 3) Drop the stone (or egg, or whatever; or, have this done by a friend) and **snap the shutter as soon as the impact has begun** — that is, as soon as the object reaches its destination. Your photograph will be exposed at the speed selected up to 1/50,000th second — far faster than the costliest shutters permit.

You'll be amazed at the results!

Note: The **Accessory Sunpak Sound Synchronizer** is a precision electronic instrument which automatically 'trips' the flash when a pre-selected sound signal (such as clapping hands) is activated. It is intended for use in a darkened room, with the camera's shutter at 'B' position. It may be adjusted to fire the flash once, or in repeated bursts of light for multi-image effects (see p. 34).

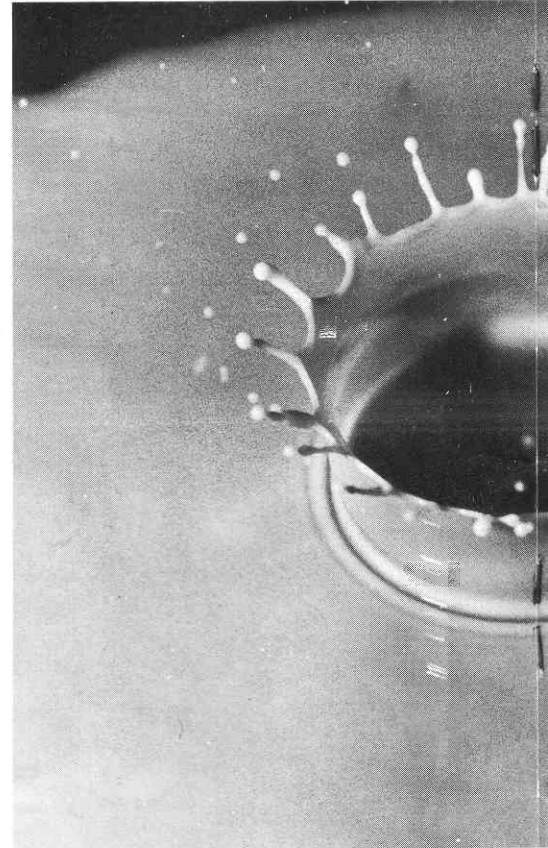

XI) MANUAL OPERATION

Shooting At Controlled Recycling Times

On "Automatic", your Sunpak Auto 611 will provide exactly the volume of light required, then save the remaining energy for subsequent shots. Many photographers, however, require the ability to shoot shot after shot very rapidly irrespective of flash-to-subject distance. Example: Photography of a sporting event with a motor-driven camera. Here, the Sunpak Power Ratio Control again provides a practical solution:



- 1) Follow this rule: Each one-step reduction in operating "Power Ratio" reduces recycling time by approximately 50%.
- 2) Determine recycling time to "Full" power (manual) with your equipment and fresh batteries (or AC current should this power source be selected). Example: Recycling speed with SUNPAK Battery Cluster Type CL-1 is determined to be approximately 9.5 seconds at Full power.

- 3) Set flash to 'Manual' — and select Power Ratio accordingly! If exposures every five seconds are required, operate at 1/2 power. For exposures every second, a Power Ratio of 1/8th is thus indicated. (Note: As battery power may diminish in use, it is recommended to choose an even smaller Power Ratio wherever possible; for example, shoot at 1/16 power when it is known that 1/8 power will provide the approximate recycling speed required. This practice will compensate for inevitable fluctuations in line and battery voltage, differences in temperature, etc.)

- 4) Set lens to correct aperture for flash-to-subject distance, as indicated by Flash Calculator Dial. Then, shoot... again and again!
- * Use of the optional Sunpak Professional 510v Battery Pak will shorten recycling times by as much as 500% ... allowing, at smallest Power Ratios, operation of motorized cameras at the highest rates of speed. See p. 33 for additional information on this valuable accessory.
 - * Use chart on p. 21 as a guide to optimum recycling speeds. For critical applications, individual tests are suggested with your equipment and power sources to determine exact recycling speeds under typical working conditions. These tests will accurately reflect usable recycling speeds with your "system"



Approximate Flash Speeds and Recycling Times with SUNPAK Auto 611 (Manual)

Power Ratio	Flash Speed (Duration)	With 510v Powerpak	Optimum Recycling Times (Apx.)	
			With Nicad Cluster	With C Nicad
Full	1/400th sec.	2 Sec.	9.5 Sec.	9.5 Sec.
1/2	1/800th sec.	1 Sec.	5 Sec.	5 Sec.
1/4	1/1600th sec.	0.5 Sec.	2.5 Sec.	2.5 Sec.
1/8	1/3200th sec.	0.3 Sec.	1.5 Sec.	1.5 Sec.
1/16	1/6400th sec.	0.25 Sec.	0.7 Sec.	0.7 Sec.
1/32	1/12500th sec.	0.25 Sec.	0.4 Sec.	0.4 Sec.
1/64	1/25000th sec.	0.25 Sec.	0.25 Sec.	0.25 Sec.
1/128	1/50000th sec.	0.25 Sec.	0.25 Sec.	0.25 Sec.

* As shown on your flash unit's Calculator Dial, wider lens openings are required when shooting at smaller Power Ratios. To obtain the greatest distance range when using small Power Ratios in high-speed operation, use the fastest available ASA film speed. For example, with ASA 25 color film the

effective Guide Number is 14 at 1/32nd power — restricting you to distances up to five feet with an f/2.8 lens. By using ASA 400 film, your Guide Number would be increased to 56 — permitting use at 20 feet with the same f/2.8 lens. (see Guide Number chart, p. 23)

Note: Your Sunpak features an extremely efficient system for heat dissipation. With motor-driven cameras, you may take advantage of the ultra-fast recycling times without fear of damaging the flash. However, your flash should be given a few minutes 'rest' after each hour of continuous or extremely-heavy rapid-sequence operation. (This recommendation applies exclusively when your flash is used with motor-driven cameras at speeds of two frames per second or more.)

XII) MANUAL OPERATION

Choosing Guide Numbers

A "Guide Number" is simply a number expressing the power of a flash unit in relation to the sensitivity (ASA film speed) of a particular film. In use, the photographer divides the flash-to-subject distance (in feet) into the Guide Number, and the result is the f/stop for correct exposure. Normally, reference to Guide Numbers is not necessary as the Computer Mechanism (and Calculator Dial) of your Sunpak Auto 611 make such calculations unnecessary. However, there are two instances in which precise Guide Number information is needed:

- 1) Use with "Flashmatic" (G.N.) Lenses Or Cameras. With lenses (or cameras) of this type, the flash unit is set to Manual and the lens aperture is automatically set as you focus. For correct exposure with such cameras or lenses, the Guide Number for your film/flash combination must be set on the Guide Number Scale of the lens.
- 2) In certain highly specialized areas of technical photography, the photographer may wish to judge the exposure by means of formulas based on Guide Numbers.

Here, the unique thyristor Power Ratio Control of the Sunpak Auto 611 provides even greater versatility — for with any ASA film speed, you may in effect **select the Guide Number** ... simply by moving the Power Ratio Control to the position indicated in the Guide Number Chart (P. 23).: Any of **eight** Guide Numbers may be selected for a given ASA film speed!

- * Individual photographers will immediately discern other areas in which the unique thyristor-linked variable power control mechanism will prove an aid to better photography. Obvious situations would include **multiple-light portrait and product photography**, where an entire series of pictures may be taken with the "ratio" or relative strength of main, fill, and back-lights adjusted by means of the Power Selector — no need to move flash units or light stands back and forth as before!
- * Another important advantage: **Obtaining extra flashes in emergencies** where replacement batteries are not conveniently available. For example, you're shooting a wedding ... and halfway through, the recycling time lengthens substantially, indicating that fresh batteries or recharging are needed. Solution: switch to "Manual" operation at a fractional power setting such as 1/4th or 1/8th power — and increase the available number of flashes — irrespective of distance — accordingly: approximately 4X as many on 1/4th power, 8X on 1/8th, and so on.

Guide Number Selector for SUNPAK Auto 611

ASA Speed Power Ratio	12	16	20	25	32	40	50	64	80	100	125
Full	56	64	71½	80	90	101	113	128	143	160	180
½	40	45	50½	56	64	71½	80	90	101	113	128
¼	28	32	36	40	45	50½	56	64	71½	80	90
⅛	20	22⅔	25¼	28	32	36	40	45	50½	56	64
1/16	14	16	18	20	22⅔	25¼	28	32	36	40	45
1/32	10	11⅓	12⅔	14	16	18	20	22⅔	25¼	28	32
1/64	7	8	9	10	11⅓	12⅔	14	16	18	20	22⅔
1/128	5	5⅔	6⅓	7	8	9	10	11⅓	12⅔	14	16

Notes:

ASA Film Speeds shown correspond to ASA indices on Auto 611 Calculator Dials.

160	200	250	320	400	500	640	800	1000	1250	1600	2000	2500	3200
202	226	254	286	320	360	404	452	508	566	640	720	808	904
143	160	180	202	226	254	286	320	360	404	452	508	566	640
101	113	128	143	160	180	202	226	254	286	320	360	404	452
71½	80	90	101	113	128	143	160	180	202	226	254	286	320
50½	56	64	71½	80	90	101	113	128	143	160	180	202	226
36	40	45	50½	56	64	71½	80	90	101	113	128	143	160
25¼	28	32	36	40	45	50½	56	64	71½	80	90	101	113
18	20	22⅔	25¼	28	32	36	40	45	50½	56	64	71½	80

XIII) CLOSE-UP AND MACRO PHOTOGRAPHY WITH YOUR AUTO 611

One of the most fascinating and rewarding of all photographic fields is the realm of close-up photography. Your Sunpak Auto 611 offers many practical benefits for superior close-ups...



1) In Automatic Operation Using Close-Up Or Macro Lenses (Without Extension Tubes or Bellows).

- A) Select smallest available auto lens opening. (Example: f/11 with ASA 100 film.) Set Auto Exposure Dial and lens to this opening.
- B) Hold (or position) flash so that the front of the flashtube housing is at least 19" from the subject.

If possible, detach flash bracket and mount your flash on a tripod for utmost stability. Should this not be possible, you may loosen the retaining screws of the bracket clamp (see p. 8), and reposition the flash handle so that it is lower and aims the flash directly at your subject. Alternatively, the flash may be 'bounced' off a simple white card or equivalent (see p. 13)

- C) **Take The Picture!** So long as the flash unit is 19" or more from the subject, and the sensor is aimed towards the subject, your photograph will be correctly exposed — automatically.

2) In Manual Operation with Extension tubes or Bellows.

Bellows units and extension rings allow close-ups to life-size (24 x 36 mm) or larger. Here, flash is needed more than ever ... yet your camera and lens are only inches away from the subject — too close for accurate automatic exposure operation. And ... when using bellows units or extension rings, an increase in exposure ("Exposure Factor") becomes necessary. Solution: Sunpak Auto 611 and its unique Power Ratio control!

- A) Place your flash so that the reflector surface is approximately 19" (1.6') from the subject.
- B) On your Sunpak Manual Power Ratio Dial, set the ASA speed for film in use. Then, turn the Power Ratio Dial to align the distance (1.6') with the smallest possible aperture of the lens. Example: f/16. Set your lens to this opening.

C) Your flash is now set for the correct Power Ratio setting for normal photography. Example: With ASA 100 film, correct Power Ratio position at 1.6' is 1/32nd.

This setting is the correct one for all exposures **not** requiring additional compensation for bellows extension or magnification. However, photography at a distance closer than about eight times the focal length of a lens requires additional exposure to compensate for the increased lens-to-film distance. This exposure factor is normally shown on scales attached to the bellows units, or in the instructional material supplied with extension tubes and bellows. Normally, this factor is applied by opening the lens to a wider aperture — which is basically undesirable in close-up photography. To apply it, and continue shooting at the same lens opening regardless of the "exposure factor", simply...

D) Multiply the "exposure factor" by the **Power Ratio** originally obtained for uncompensated exposures at 1.6". Example: Shooting at 1:1 (1X—life size), the indicated exposure factor with your bellows unit is "4". You have already determined a Power Ratio setting of 1/32nd for uncompensated exposures. $4 \times 1/32 = 4/32 = 1/8$; the correct Power Ratio is in this case 1/8. Set this Power Ratio... and shoot—no further adjustment of any sort is required!

* This procedure is applicable not only to photography of three-dimensional objects but in **slide duplicating** as well. In use, the flash is placed 19" from the outer surface of the duplicator. A film test is suggested to determine the absorption factor of the diffusion shield normally used with slide copiers; this factor is then applied to the ASA film speed and operation from that point carried out as described above. If the original slide is **under-exposed**, adjust the Power Ratio control to provide more light — for example, 1/4th power instead of 1/8th. If the slide is **over-exposed**, reduce brightness by adjusting the Power Ratio control to provide **less** light (example: 1/16th power instead of 1/8th).

* Placement of the flash at 19" or more from the subject is strongly recommended. At this distance, a wide light path is obtained: Equally important, light output of the flash is uniform. Using your flash at closer distances may result in over-exposure as well as possible misdirection of the light.

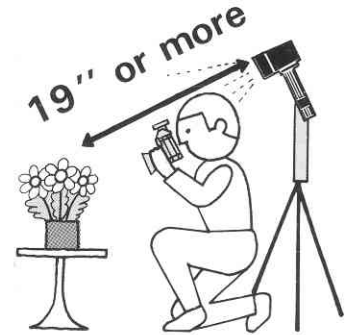

Exposure Factor Guide for Macro Photography When Using Extension Rings or Bellows

Magnification Ratio	Field Size ①		Exposure Factor ②
	35mm	6x6cm	
0.1x	240x360mm	560x560mm	1.2x
0.2x	120x180mm	280x280mm	1.4
0.3x	72x108mm	168x168mm	1.5
0.4x	60x90mm	140x140mm	2.0
0.5x	48x72mm	112x112mm	2.3
0.6x	40x60mm	93x93mm	2.6
0.8x	30x45mm	70x70mm	3.2
0.9x	27x40mm	62x62mm	3.5
1.0x	24x36mm	56x56mm	4.0
1.2x	20x30mm	47x47mm	4.8
1.4x	17x26mm	40x40mm	5.8
1.6x	15x22mm	35x35mm	6.8
1.8x	13x20mm	31x31mm	7.8
2.0x	12x18mm	28x28mm	10.0
2.5x	10x15mm	22x22mm	12.0
3.0x	8x12mm	19x19mm	16.0
3.5x	7x10mm	16x16mm	20.0
4.0x	6x9mm	14x14mm	25.0
6.0x	4x6mm	9x9mm	50.0
8.0x	3x4.5mm	7x7mm	80.0

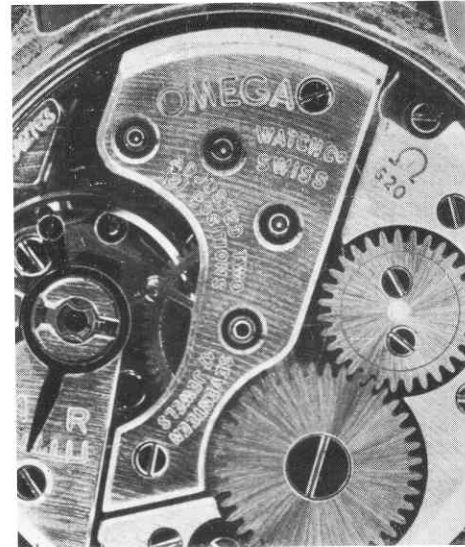

Notes: ① Field size shown represents total area recorded on negative at magnification shown. SLR viewfinders generally show a somewhat smaller field than is actually recorded on film.

② Exposure Factors actually vary for specific lenses. Use suggested factors shown as a guide; for most precise information, please contact manufacturer of lenses in use.

* When using close-up attachment over the lens, increasing of exposure is not required.

XIV) MULTIPLE FLASH OPERATION

For genuinely professional lighting effects, the only thing better than a Sunpak flash is ... **two** Sunpaks! (Or more.) It's easy to use your Sunpak in conjunction with another Auto 611, or almost any other electronic flash.

Understanding Multiple Flash

- * The 'main' flash is the one which is attached to the camera. A light-sensitive **slave unit** is attached to each of the 'remote' (other) flash units; when the main flash is fired, the other flash units are triggered — in perfect synchronization — by the slave units. The only cord involved is the one going from the 'main' flash to the camera, so you don't have to contend with wires dangling across the floor.
- * The **Sunpak Auto Slave** is a perfect partner for your multiple-flash work. It's very small, requires no batteries, and is extremely sensitive — being able to trip an extension flash even with indirect or bounce lighting at distances up to 100 feet or more. It plugs into the PC cord of the extension flash (or into the Remote Sensor of your Auto 611 if the 611 is used as a 'remote' flash).

Although the Sunpak Slave is very sensitive to electronic flash light, it's unaffected by bright 'ambient' room light or even daylight — so your flash won't go off accidentally. And the Sunpak Auto Slave is supplied with a handy adapter that lets you attach any shoe-mount flash to any standard tripod.

All you need is your Sunpak Auto 611, one or more extra flash units equipped with Sunpak Slaves ... and you're ready for professional multiple-light effects. Here's how:

- 1) **Arrange main and remote flash units** as desired (see diagrams, below).
- 2) **Attach Slave Units to Remote Flashes**, and PC cord of main flash to camera. Turn flashes 'On', and set each flash for **Manual** operation.
- 3) **Determine the lens opening for the most important flash** — the one which puts the most light on the subject. (In almost all instances, that will be the Auto 611.)
- 4) **Set your lens to an opening one f/stop SMALLER** than is indicated for the flash-to-subject distance of the **most important flash** — for example, to f/11 when f/8 is indicated by your Auto 611 Manual Exposure Calculator Dial.
- 5) **Take The Picture!** In almost every instance, this simple technique will insure a correctly-exposed photograph. (See specific exposure information beside diagrams, right)

Use This Arrangement

For This Effect

* For optimum exposure accuracy in multiple flash photography, use of an electronic flash meter is suggested. This measures the total useful light of any combination of flash units, showing the exact lens opening for optimum exposure. Information on the Gossen Electronic Flash Meter system may be obtained from Sunpak dealers or from Gossen, Box 1102, Woodside, New York 11377.

* Do not use extension cords to trip the remote flash units. The low-voltage circuits of modern electronic flash systems often fail to trigger when long cords are employed. Slave units are more convenient and much more reliable.

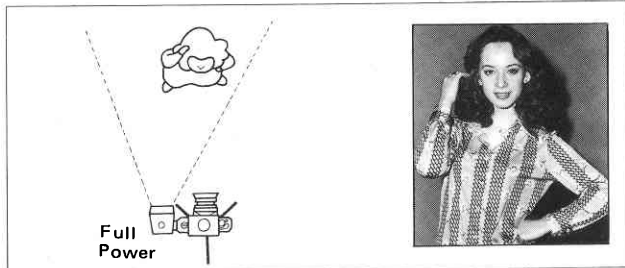

Notes:

Standard lighting makes deep shadow right side of subject.

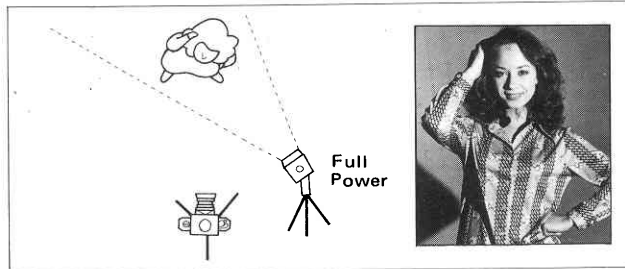

611 at full power, slanting lighting makes high contrasty picture and more cubic picture will result than straight lighting like above.

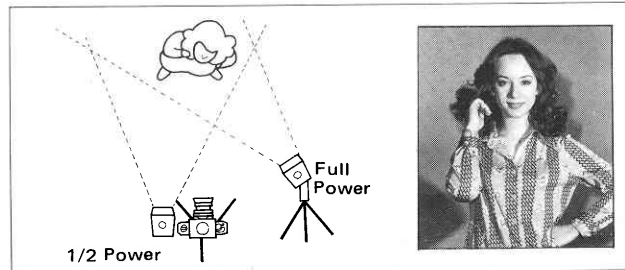

Here, another 611 at 1/2 power (or a small shoe-mount flash like Sunpak 200) is used with the camera. It gives fill-in light to weaken high contrast nicely and trip the 611 at the ether side. You will see the picture is much better than aboves.

Use This Arrangement

For This Effect

Notes:

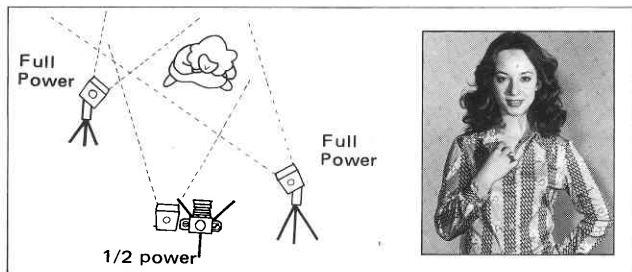

Same as afore-mentioned, except note how the background is now much brighter. Here, another 611 at full power with slave was placed behind the subject, aimed at the background. It gives a lighter 'mood' to the portrait.

* These basic diagrams will suggest many creative potentials to the photographer. For a comprehensive analysis of professional multiple-flash technique, please refer to the publication "Professional Portrait Techniques", No. O-4H, published by the Eastman Kodak Company. Your dealer can supply you with this and other valuable books on professional lighting techniques.

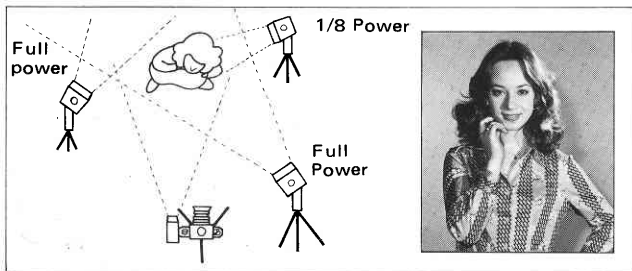

By aiming another 611 at 1/8 power (or a small shoe-mount flash like Sunpak 100) at the subject's hair, a sparkling, natural looking 'highlight' is obtained. Best for women! No change in exposure is needed, since the extra flash doesn't put more light on the face.

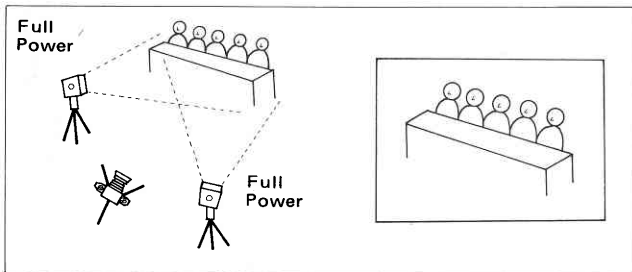

If shot "head on", this picture would be 'flat' and uninteresting. But no one flash can light nearest and farthest subjects with equal brightness. With two flashes, it's easy.

XV) USING FILTERS FOR SPECIAL EFFECTS

The Flashtube Housing of your Sunpak Auto 611 accepts filter holder (optional) to slide-in filters for special-effects applications. While not necessary in normal picturetaking, such filters offer a wide range of creative possibilities for altering color balance for a desired effect. Your dealer can supply you with economical acetate or gelatine filters in squares, which are simply trimmed to fit. For a complete filter "system", you may obtain a **Chromega CP Filter Set** (a product of Berkey Marketing Companies' Omega Division, Box 1102, Woodside, New York 11377) containing 23 3" x 3" filters in the most popular shades of cyan, magenta, and yellow; these economical filters will give you a wide range of special-effects capabilities and allow you to 'warm' or 'cool' the color of the flash at will.

- * No filters are required for light dispersion when using your flash with wide-angle lenses up to 35mm (on 35mm cameras) or 75mm (on 2¼" x 2¼" cameras). With ultra-wide angle lenses of shorter focal length, some edge darkening may be apparent. Should this occur, use your Auto 611 exclusively in 'bounce' mode with such lenses to insure even illumination.
- * When using your flash on 'Automatic', no compensation is required for exposure as the Remote Sensor is measuring the light actually emitted by the flash. However, when using filters with appreciable light absorption or dispersion, remember that the **usable maximum distance** is reduced proportionately.



XVI) NICAD CLUSTER

After you have taken flash pictures, the recycling time (interval between flashes until the Ready Light glows) will become progressively longer. When this time exceeds 15 seconds, the Nicad Battery Cluster should be recharged.

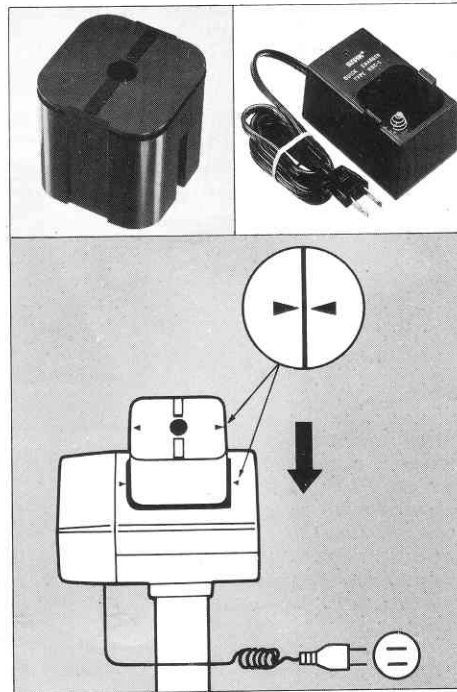

BATTERY CHARGING

- 1) Remove Battery Cluster from unit.
- 2) Insert the Battery Cluster into compartment of SUNPAK Quick Charger Type QBC-1.
- 3) Plug Charger, Cord into 100–120V AC outlet.

Your Nicad Cluster will recharge fully in approximately three hours. (Time will be shorter if the Battery Cluster is not completely 'drained'.) However, in most stances sufficient energy will be accumulated within 15 minutes to permit 10 or more flashes in automatic operation at short distances. (As line voltage can vary appreciably in some areas or during 'brown-outs', charging for an additional 30 minutes—1 hour may prove advisable.)

- * No harm will result to your Charger or batteries if the Charger is left on for period of up to 72 hours. However, the Charger should not be left on for more than 3 days.
 - * If using individual 'C' nickel-cadmium batteries (optional), please refer to instructions supplied with these batteries or their charger.
 - * Do NOT attempt to recharge any battery other than the Sunpak Nicad Cluster inside your recharger unit.
- 1) **Use Correct Batteries.** This flash unit is designed for optimum performance when used with the Sunpak Nicad Cluster, 510V Powerpak, and 'C' size nickel-cadmium batteries. Other battery types (alkaline, zinc-

XVII) CARE OF YOUR ELECTRONIC FLASH

carbon, or rechargeable batteries other than nickel-cadmium) should be used in emergencies exclusively, due to the much longer recycling times and smaller number of flashes obtained.

- 2) **Inspect Batteries Frequently.** 'Inspect' means for reasonable recycling time (the length of time it takes the indicator light to come on between flashes); if it's more than 15 or 20 seconds, or if, in 'Auto' mode, the Auto Signal Lamp goes off for one second or more, your batteries should be recharged (if Nickel-Cadmium) or replaced (if 510v). It's also wise to check individual batteries for **appearance**: sometimes, even the best of batteries discharge or leak some chemical material through the jacket ... and leave a whitish-powder on the battery, which passes onto your Sunpak's electrical contacts. (If this has happened, replace the batteries after cleaning the Sunpak's internal battery contacts with a penknife.) Finally, it's a good idea to remove the batteries or Battery Cluster once in a while and wipe with a handkerchief — the cleaner the battery surfaces, the easier it is for the energy to pass through your flashgun's electrical system.

- 3) **Remove Batteries For Storage.** If for some reason you do not intend to use your flash for a period of several weeks or more, remove the batteries and store them separately (inside a plastic bag is a good way).

- 4) **Make Sure Flash Is Securely Attached** to bracket and that bracket is securely attached to your camera!

- 5) **Store Flash Carefully.** When you're done using your flash, detach the mounting bracket by pressing in the release button (turn Locking Ring counter-clockwise if release button will not operate). Remove flash bracket from camera, and carefully store flash unit, bracket, and cord ... together, so they'll be ready next time you're taking pictures!

As with any precision instrument, protect your flash from moisture, extended exposure to extremely hot (e.g. trunk of car) or cold temperatures, or hard bumps or jolts. You'll be rewarded with thousands of excellent exposures...

- 6) **Service.** In the unlikely event that your Sunpak electronic flash requires service, return it to your dealer or the sole U.S. Distributor. Do not, under any conditions, attempt to disassemble and/or adjust the Flash Unit, Battery Cluster, or electrical accessories yourself: electronic flash operates on high voltage, and should not be taken apart. However, keep in mind that flash failure is more likely to result from weak batteries than any other single cause: if it doesn't fire, check batteries and contacts (including shutter cord) carefully.

XVIII) MAJOR ACCESSORIES FOR THE SUNPAK AUTO 611

Your Sunpak Auto 611 Thyristor flash accepts a comprehensive system of flash accessories. Here are the most important ones:

1) Sunpak Professional 510v Powerpak (Cat. No. 651-723). This is a compact auxiliary power source which accepts a 510v dry battery (Eveready #497 or equivalent). The 510v battery will give a **minimum** of 70 flashes (full power, manual) and **as many as 5,000** in automatic or fractional-power operation. Many professionals prefer this power source as it yields the fastest recycling times, and greatest number of uninterrupted flashes, of all battery types. The 510v Powerpak is supplied in a convenient leather case with strap, and may be worn over the shoulder or belt-mounted.

This Powerpak incorporates an automatic voltage regulator, which signals if battery power is above the level for consistent operation. Neon lamp on top of Powerpak goes 'off' if battery power drops below the level. It is supplied with a detachable 5' coiled cord connecting to the AC Outlet of the flash. For remote-control applications, a special 10' coiled Connecting Cord (Cat. No. 651-754) is also available.

2) Extra Sunpak Nicad Battery Cluster (Cat. No. 651-725). Special Quick Charge Nicad Module recharges separately from flash, so if you have two Nicad Battery Clusters, you can use one as the power source of Auto 611 unit, while charging the other in the Charger.

3) Sunpak 6 x 6 Mounting Bracket (Cat. No. 651-752). This is an oversize square camera support that's excellent for use with 2 1/4" x 2 1/4" (6 x 6 cm) single and twin-lens reflex cameras. It attaches to the quick-release clamp supplied with your flash. Gives extra stability convenience with 2 1/4" cameras.

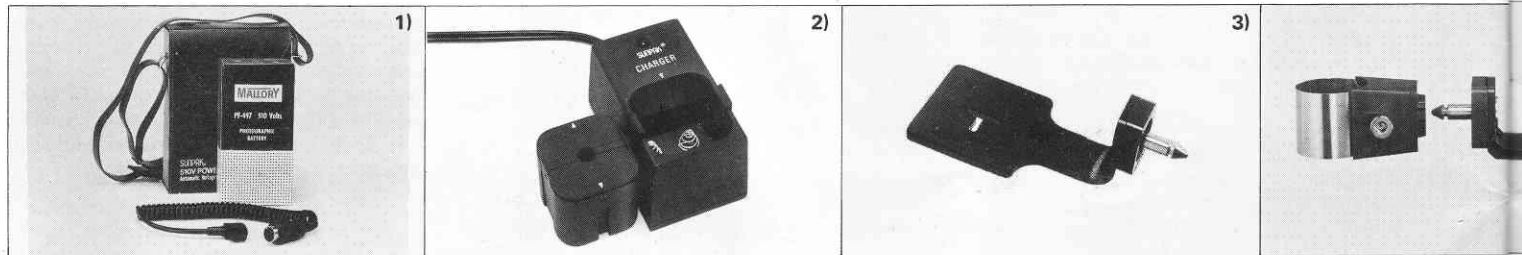

4) Sunpak Adjustable Locking Bracket (Cat. No. 651-750 Clamp, No. 651-751 Bracket) ▲ deluxe version of the standard camera bracket, with special 'locating' pins which lock the camera on the bracket, preventing any inadvertent shift of camera while on bracket. It's a valuable accessory with heavy cameras with motor-drive attachments, or large-format cameras such as the Koni-Omega and Rapid Omega. Attaches to standard Sunpak Quick-Release Clamp.

5) Sunpak Auto Slave (Cat. No. 651-715). A very handy, very dependable accessory when you're using two or more Sunpak flash units (see p. 28). Attaches to PC Cord of Auto 611 and most other flash units; has a unique suction-cup base that lets you attach it to almost any part of the flash in use. Also includes an adapter permitting mounting any shoe-mount flash on a tripod.

6) Replacement Sunpak Coiled Flash Cord (Cat. No. 651-753). This cord is needed only when your Auto 611 is used in manual mode (without the Remote Sensor). One end attaches to any PC shutter contact; the other plugs into the flash unit, using Sunpak's unique three-prong safety plug fitting that makes it impossible to insert the cord into an AC outlet — even accidentally.

Owners of Koni-Omega, Rapid Omega, Kowa Super 66, and similar cameras with screw-lock PC outlets may prefer the optional **screw-lock PC cord** (6', coiled), Cat. No. 706-214.

The Sunpak Auto 611 also accepts any conventional two-blade (household-type) flash cord. Such cords do not incorporate the Sunpak safety 'prong', but operate perfectly with your flash unit.

7) Sunpak Sound Synchronizer (Cat. No. 651-713). A compact electronic device which fires your Auto 611 and other flash units at a predetermined signal, such as a breaking bottle, clapping hands, or any other noise. May be set for single or continuous flashing; adjustable for volume of signal and for flashing delay. For complete specifications, please contact your Sunpak dealer or the manufacturer.

Note: Replacement cords, clamps, and other 611 components are available from Sunpak dealers.

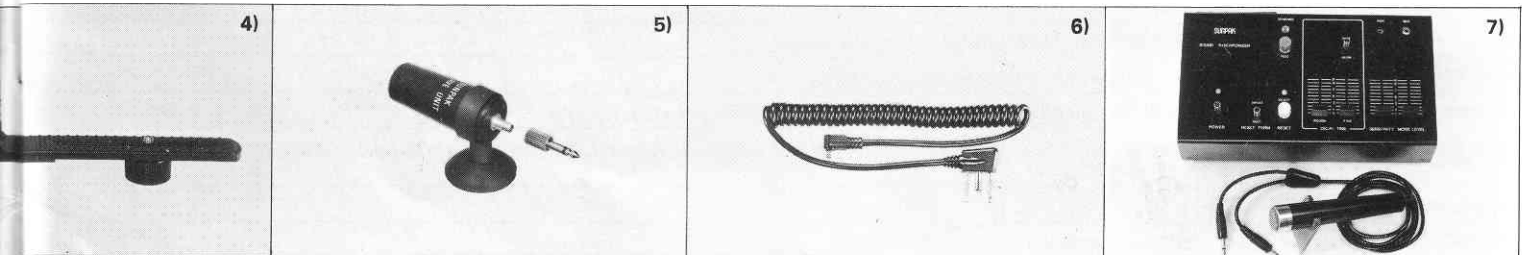

XIX) TECHNICAL SPECIFICATIONS OF SUNPAK AUTO 611 THYRISTOR FLASH

Flash Type	Professional Handle-Mount Auto and Manual with Remote Sensor.				
Light Output In BCPS	4,000				
Guide Numbers	With ASA 25 film, infinitely variable from 80 (at full power) to 7 (at 1/128th power). With ASA 100 film, from 160 (full power) to 14 (at 1/128th power).				
Angle of Illumination	In direct flash, 60° Horizontal by 45° Vertical; permits use of 35mm wide-angle lenses on 35mm cameras, 70mm wide-angle lenses on 2¼" x 2¼" cameras, 85mm wide-angle lenses on 6 x 7 cameras. In Bounce Flash: Omnidirectional — sufficient for use of 21mm lenses on 35mm cameras, 40mm lenses on 2¼" x 2¼" cameras, and 50mm lenses on 6 x 7 cameras (depending on ceiling height).				
Interchangeable Power Sources		With Sunpak Nicad Cluster	With Individual 'C' Nicads (4)	With 510v Battery	100—240v AC (50/60 Hz.)
	No. of Flashes (Full~1/128th power)	40~800	60~1,200	70~5,000	Unlimited
	Recycling Times (1/128 power~Full)	0.25~9.5 Sec.	0.25~9.5 Sec.	0.25~3 Sec.	0.25~30 Sec.
	Recharging Time to Full Charge Capacity	3 Hrs.			
	Recharging Time to 20 Flashes	10 Min.~1.5 Hrs.			
Flash Speed	1/400th second — 1/50,000th second (manual); 1/400th second — 1/50,000th second (automatic).				
Automatic Aperture Range	Continuous, over 4-stop range (f/4.0 — f/11 with ASA 100 film).				
Automatic Distance Range	19 inches — 40 feet (at maximum aperture) 19 inches — 14 feet (at minimum aperture).				
Remote Sensor Acceptance Angle	28°				
Power Ratio Range	Full, 1/2, 1/4, 1/8, 1/16, 1/32, 1/64 and 1/128th power.				
Color Temperature	5500° Kelvin, balanced for daylight-type color films.				
Mounting	Instantly-detachable quick-release bracket with 12-way clickstop bounce control.				
Other Features	Auto Signal Lamp confirms auto operation and correct exposure; Ready Light glows at 100% power; Remote Sensor with hot shoe and detachable PC Cord.				
Dimensions	4.8" x 3.8" x 10" (flash); 2.5" x 2" x 1" (Sensor).				
Weights	34.5 Oz. (flash, less batteries); 2.5 Oz. (Sensor).				

All Specifications Subject to Change without Notice.

XX) ABOUT THE MANUFACTURER.....

For nearly two decades, the innovative technology and meticulous craftsmanship of Sunpak electronic flash units have led to their selection by more than *seven million* photographers throughout the world.

Each flash unit is manufactured in its entirety by Sunpak Corporation, and is designed to offer significant benefits for superior flash pictures.

Many important patents in electronic flash technology are held by Sunpak, including that for the unique Thyristor Variable Power Ratio system of this flash. Additionally, each Sunpak unit is equipped with a special Gold-Toned flashtube, specially coated and pre-flashed to assure optimum color balance with today's color film types without use of corrective filters.

Prior to release, each Sunpak flash model is subjected to numerous exhaustive and highly discriminate tests included impact-resistance tests at forces up to 70x gravitational acceleration, and numerous other tests both to individual components and completed flash units.

The resultant consistency and uniformity of Sunpak electronic flash systems has been yet another significant reason for their acceptance by photographers in more than fifty nations throughout the world.

Welcome.... to the Sunpak world of light!

SUNPAK®

651-766

Electronic Flash Accessory

TELE KIT™

FOR USE WITH AUTO 611

OWNER'S MANUAL



SUNPAK DIVISION
BERKEY MARKETING COMPANIES
WOODSIDE, N.Y. 11377

Copyright 1977, Sunpak Division,
Berkey Marketing Companies

Printed in Japan

INTRODUCTION

Thank you for purchasing the accessory Tele Kit for your Sunpak Auto 611 Electronic Flash Unit. The Tele Kit is designed to decrease the illumination angle of your flash while increasing the light intensity on your subject. It is designed for use with telephoto and zoom lenses from 70mm to 300mm when used with 35mm cameras. (For large format cameras, refer to the instructions).

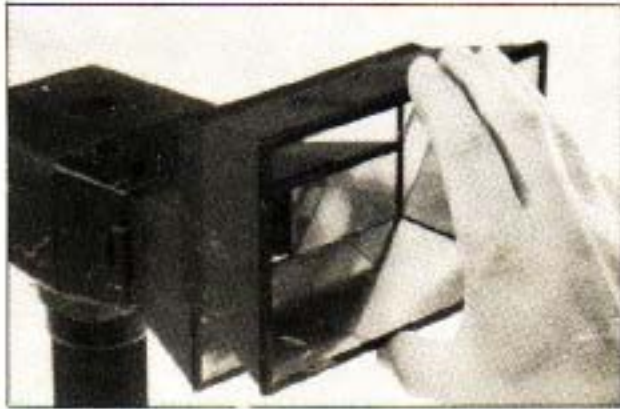
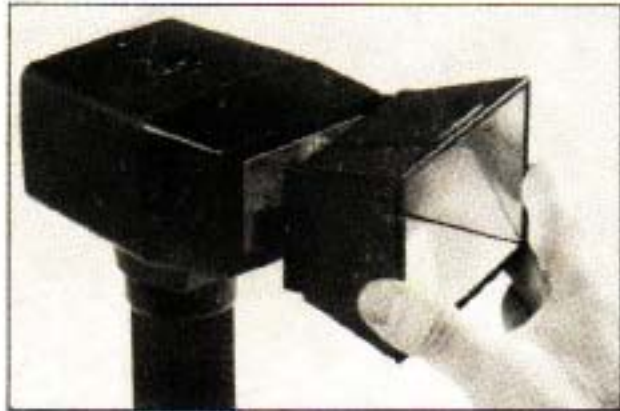

MOUNTING/ OPERATING INSTRUCTIONS

To mount the Tele Kit on the Sunpak Auto 611, simply snap it on as illustrated. The Tele Kit consists of a two-piece reflector and a built-in filter holder. With the Tele Kit, you have the ability to decrease the flash illumination angle while increasing the light intensity on your subject. The filter holder accepts either one or two filters for added color control and more creative lighting effects. The Sunpak Filter Kit (Cat. No. 651-767) is available from your Sunpak dealer and is supplied with complete instructions.

The chart below indicates the recommended Tele Kit set-ups for use with lenses of various camera formats:

Tele Kit Position	Angle of Illumination	Guide No. ASA 25	Illumination Increase	Recommended lens ranges for various camera formats		
				35mm	6X4.5	6X6-6X9
None	60° x 45°	80		35	60	80
1	24° x 19°	105	1.7 X	135	180	300
1+2	19° x 14°	120	2.3 X	300	300	400



300mm lens at 35' or more with #1 + 2 Tele Kit.



135mm lens at 30' or more with #1 Tele Kit.



50mm lens at 25' or more without Tele Kit.