



This manual is for reference and historical purposes, all rights reserved.

**This page is copyright© by M. Butkus, NJ.**

This page may not be sold or distributed without the expressed permission of the producer

I have no connection with any camera company

On-line camera manual library

This is the full text and images from the manual. This may take 3 full minutes for the PDF file to download.

**If you find this manual useful, how about a donation of \$3 to: M. Butkus, 29 Lake Ave., High Bridge, NJ 08829-1701 and send your e-mail address so I can thank you. Most other places would charge you \$7.50 for a electronic copy or \$18.00 for a hard to read Xerox copy.**

**This will allow me to continue to buy new manuals and pay their shipping costs.**

**It'll make you feel better, won't it?**

**If you use Pay Pal or wish to use your credit card,  
click on the secure site on my main page.**

# Canon

## AF35M II

## AF35M II

QUARTZ DATE 

## SURE SHOT

QUARTZ DATE 

## SURE SHOT

## Autoboy 2

## Autoboy 2

QUARTZ DATE 

**E**

English Edition



  
CAFS

INSTRUCTIONS

# NOMENCLATURE

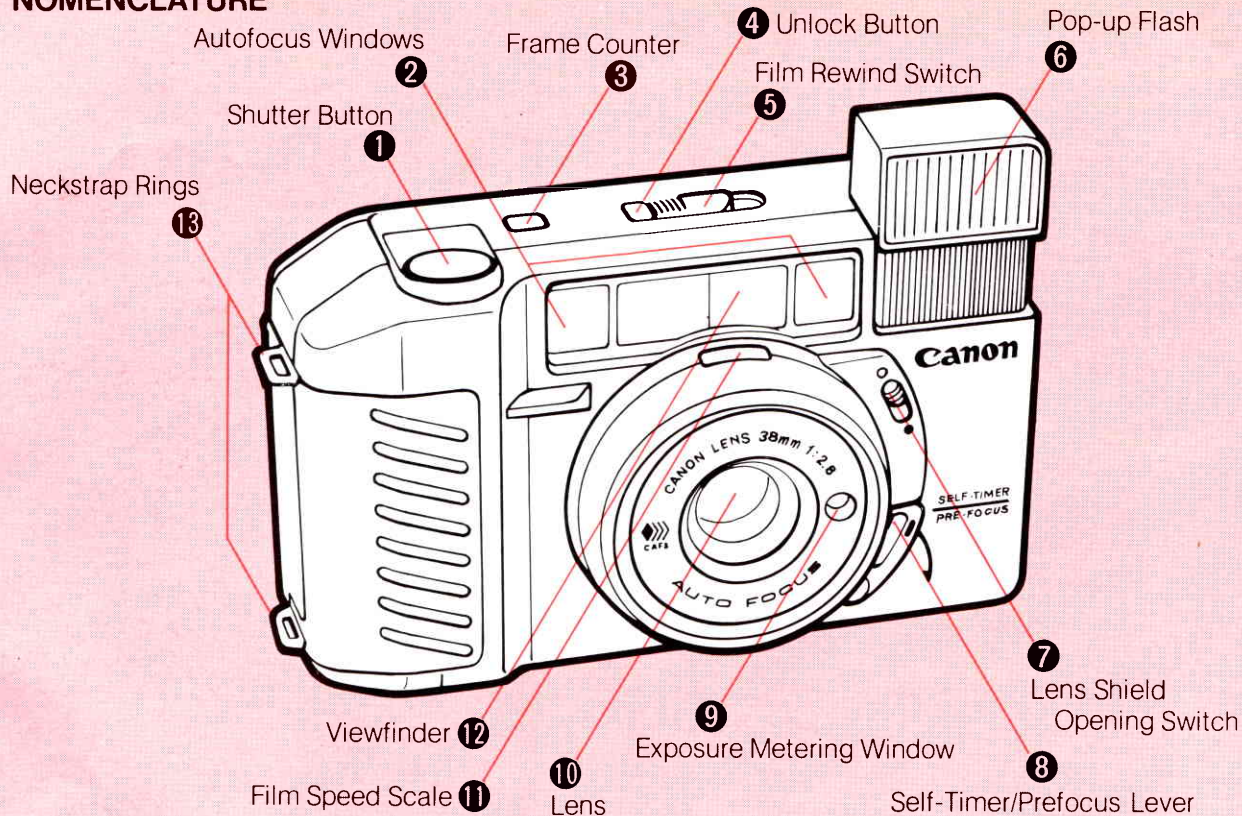

.....

**Thank you for purchasing the AF35M II/Sure Shot.\* As its name indicates, your new camera is a member of Canon's autofocus, compact 35mm family. It is equipped not only with autofocus, but with auto-wind, auto rewind, autoload, auto exposure, and prefocusing capability as well. It produces the same high-quality pictures as Canon's other compact autofocus cameras, yet is very light and compact. It suits both the beginner and the experienced photographer as a camera for traveling and snapshots.**

**Please spend a few minutes reading through these instructions before**

**you start using your new camera. Basic operations are outlined on page 6. The remaining pages describe all you'll need to know about taking pictures with the AF35M II/Sure Shot.**

*It's a good idea to acquaint yourself with the camera by first taking some pictures without any film loaded in the camera. Load the camera with film once you feel comfortable with all operations.*

*When reading these instructions, unfold the front and back flaps of this booklet for easy reference to the camera's parts.*

## **Table of Contents**

Basic Operation .....	6
1. Loading the Batteries .....	7
2. Opening the Lens Shield .....	8
3. Checking the Batteries .....	8
4. Setting the Film Speed .....	10
5. Loading the Film .....	11
6. Shooting.....	14
7. Prefocusing.....	16
8. Special Subjects.....	18
9. Using the Built-In Flash.....	19
10. Using the Self-Timer .....	21
11. Rewinding the Film.....	22
12. Neckstrap and Case .....	23
13. Specifications .....	24
14. Care of the Camera .....	27

For those who have bought the AF35M II/Sure Shot "Quartz Date" camera, additional information for date imprinting functions are provided. Please refer to it, too.

## **Basic Operation**

- 1** Load the batteries.
- 2** Open the lens shield.
- 3** Check the batteries.
- 4** Set the film speed.
- 5** Load the film.
- 6** Look into the viewfinder. Compose the picture so that your subject covers the autofocus spot.
- 7** Press the shutter button halfway. If the red viewfinder lamp blinks rapidly, switch to flash and wait for the flash-ready lamp to light up.
- 8** Press the shutter button all the way to take the picture.
- 9** At the end of the roll, rewind the film.

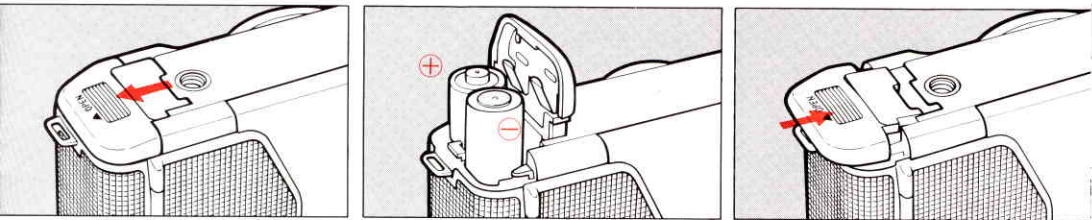

# 1 Loading the Batteries

**This camera will not work without batteries.**

Use two new size-AA 1.5V batteries of the same brand. We recommend using alkaline (LR6) batteries. Carbon-zinc batteries can also be used, but their life is shorter.

DO NOT use Ni-Cd batteries.

**1.** Wipe the battery terminals with a clean, dry cloth to ensure proper contact.

**2.** Push down on the battery chamber cover  and slide it in the direction of the arrow to open the cover.

**3.** Load the batteries, making sure to place them in the correct  $\oplus$   $\ominus$  order indicated on the diagram inside the battery chamber.

**4.** Push the cover shut.

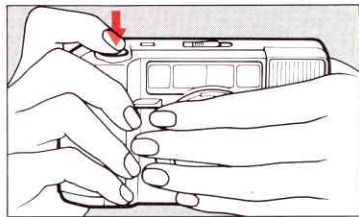
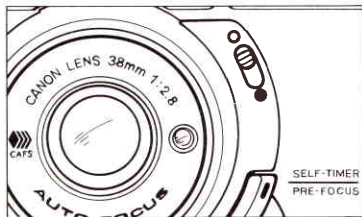
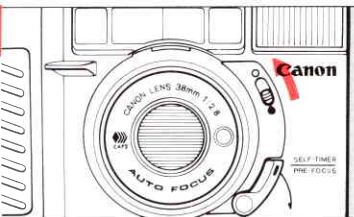

## **2** Opening the Lens Shield

To open the lens shield, push the lens shield opening switch ⑦ up. When the lens shield is closed, the camera is turned off and it is impossible to shoot. This function prevents taking pictures with the lens shield closed.

## **3** Checking the Batteries

Check the batteries before using the camera.

- 1.** Cover the lens area with your hand and press the shutter button ① halfway while looking through the viewfinder ⑩.
- 2.** If the viewfinder lamp blinks rapidly, battery power is sufficient.
- 3.** If the viewfinder lamp does not blink, replace both batteries with new ones.

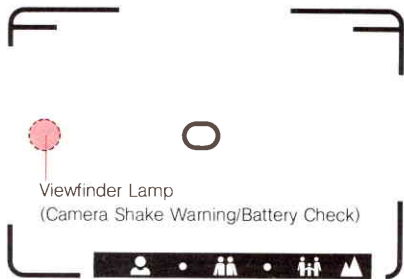

Using new alkaline batteries at normal temperatures, you can shoot:

1. Approximately fifty rolls of 36-exposure film without flash.
2. Approximately seven rolls of 36-exposure film using flash for each exposure.

- Replace the batteries if, after checking them, the viewfinder lamp does not blink.
- Battery power is reduced in very low temperatures (0°C or 32°F), making regular photography difficult. If you plan to take pictures in cold conditions, keep the camera warm until just before you shoot. It is a good idea to carry spare batteries; keep them warm also until they are needed. Don't throw away batteries that have become temporarily unusable because of cold weather. Once they have been restored to room temperature, you may be able to use them again.
- If you don't expect to use the camera for about three weeks or longer, remove the batteries so that they don't leak and corrode the camera's electrical contacts.

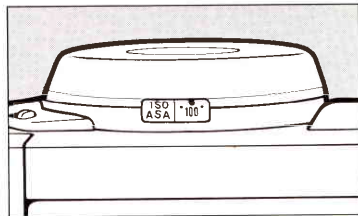
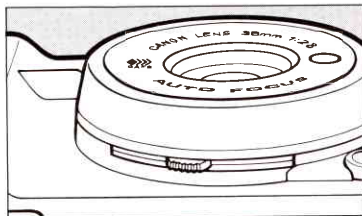
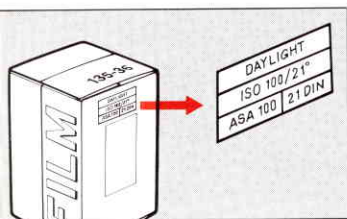

## 4 Setting the Film Speed

For correct exposure, set the film speed ring ⑳ according to the ISO/ASA number indicated on the film's cartridge and box. Turn the ring until the correct number is aligned with the white film speed index.

Reset the film speed ring each time you load film with a different ISO/ASA rating.

Because there are no click-stops between ISO/ASA 400 and 1000 on the camera, film with an ISO/ASA rating between these two numbers, for example ISO/ASA 640, cannot be used.

ISO/ASA 50<sup>(64)(80)</sup> 100<sup>(125)(160)</sup> 200<sup>(250)(320)</sup> 400 — 1000

{ Figures in parentheses are intermediate film speeds represented by dots on the film speed ring. }

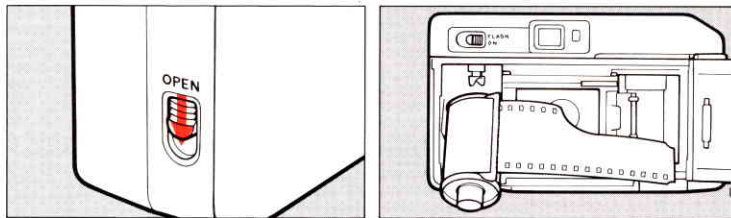

## 5 Loading the Film

Use color or black and white film in standard 35mm cartridges. Load the film in subdued lighting only.

- 1.** Push the back cover opening latch ⑭ in the direction of the arrow to open the back cover.
- 2.** Insert the upper, flat end of the cartridge into the film chamber first, then lower the other end. The cartridge should be fully seated, not tipped upward.

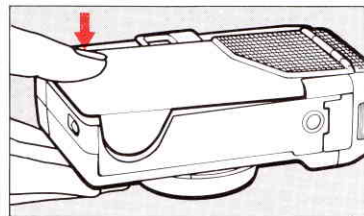
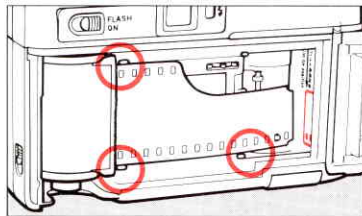
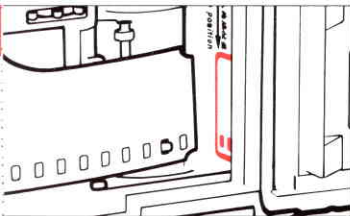

**3.** Pull the film leader across the back so that its tip is aligned with the orange line in the lower right hand corner of the film chamber.

**4.** Place the film between the film guides, and close the back cover.

**5.** Press the shutter button ① several times until the frame counter reaches "1." If the frame counter moves, the film is being properly transported. If it does not move, reload the film.

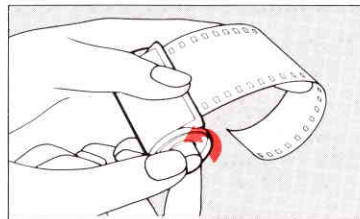

If the film leader extends past the orange line, manually wind the excess film back into the film cartridge. Film will not wind properly if there is too much film slack.

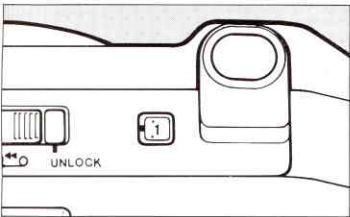

Film Chamber

Take-Up Spool

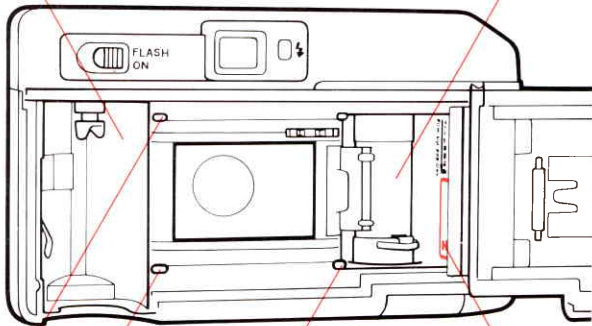

**X**

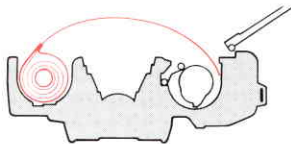

Too much film slack.

**OK**

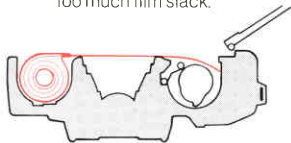

Film will wind properly.

Film Guide

Orange Line  
(Film tip position)



## 6 Shooting

**1.** Look through the viewfinder ⑩ and compose the picture so that the main subject covers the autofocus spot.

For close subjects between 90cm (3 ft.) and one meter (3.3 ft.), compose the picture so that the subject is within the parallax correction frame inside the viewfinder. The closest possible shooting distance is 90cm.

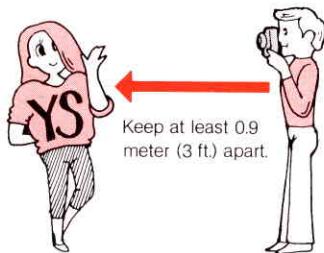

**2.** Gently press the shutter button ① HALFWAY. If the viewfinder lamp blinks rapidly, switch to flash. This lamp warns you when insufficient light may cause overly dark or blurred pictures.

**3.** Hold the camera in both hands with at least one elbow steadied against your body. Then gently press the shutter button all the way down to take the picture.

Parallax Correction Frame

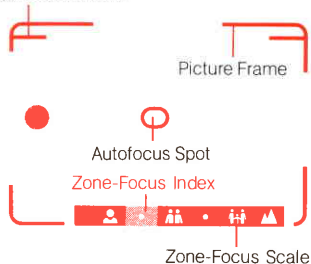

As the picture is taken, the green zone-focus index in the viewfinder will shift to a symbol, indicating the shooting distance which has been automatically selected by the camera. By watching this index as you shoot, you can tell approximately at what distance the camera was focused.

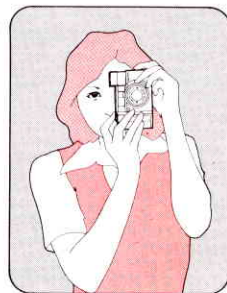

**4.** After you take your finger off the shutter button, the camera's built-in power winder will automatically advance the film to the next frame. As the film advances, the frame counter will also advance one frame. It can count up to 36 frames.

Be sure the flash, lens, exposure metering and auto-focus windows are not blocked by your fingers or hair.

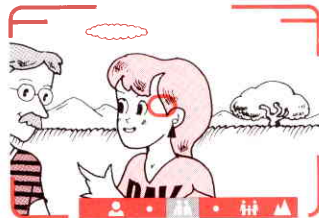
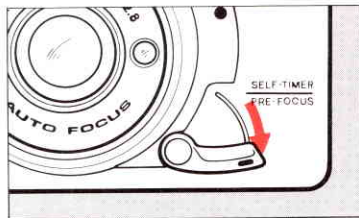

(illus. A)

## 7 Prefocusing (or: How to focus when you don't want your subject in the

Normally, in order for your subject to be in correct focus, it must cover the autofocus spot in the center of the viewfinder. If you want to compose the picture so that your main subject is not covering that spot, follow these steps:

1. Rotate the self-timer/prefocus lever ⑧ in the direction of the arrow until it stops.
2. Look into the viewfinder and compose the picture so that your main subject covers the autofocus spot. Then press the shutter button all the way down. The camera will memorize

the distance between you and the subject, and the zone-focus scale will indicate this distance in the viewfinder (illus. A).

3. Recompose the picture so that your subject is where you want it to be, but DO NOT change the shooting distance (illus. B).
4. Press the shutter button again for exposure.



(Illus. B)

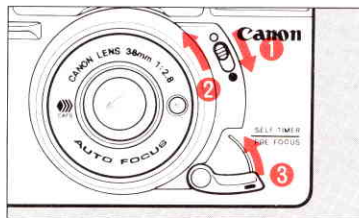

center of the viewfinder.)

Setting the prefocus lever also sets the self-timer. Unless you take the shot soon after pressing the shutter button in step 2, the shutter will be released automatically at the end of about ten seconds by the self-timer.

If you want to cancel prefocus after you've pressed the shutter button, follow these steps:

1. Push the lens shield opening switch down ① and then up ②.
2. Rotate the prefocus lever to its original position ③.

## 8 Special Subjects

There are a few types of subjects for which the autofocus system is not perfectly suited. They include:

1. Glossy subjects (exterior of a car, glass, water).
  2. Subjects which have little or no reflectance (black hair, fire, fireworks, blackout curtains).
- For these types of subjects, it is best to pre-

focus. Follow the steps for prefocusing listed on page 16, but in step 2, compose the picture so that a substitute subject, which is the same distance from you as the main subject, covers the autofocus spot.

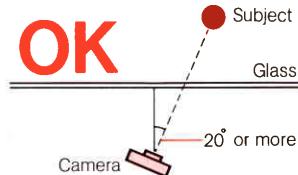
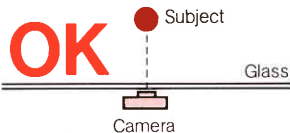
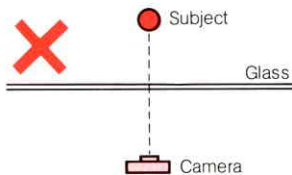

- When you photograph a subject through glass, either press the camera to the glass surface or shoot at an angle of  $20^\circ$  or more.

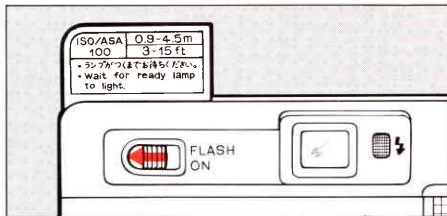

## 9 Using the Built-in Flash

Switch to flash photography at the following times:

- If the red viewfinder lamp appears when you press the shutter button halfway. In this case the flash will prevent the photo from being blurred and underexposed.
- If the sun or a lamp is behind your subject.
- If there is a bright window at your subject's back.
- If your subject is in shadow.

In the last three cases, the flash will prevent your subject from turning out too dark if it is

within 3m (10 ft.) of you.

- 1.** Push the flash switch ⑮ in the direction of the arrow. The built-in flash will pop up.
- 2.** Look into the viewfinder and compose the picture as you would for normal photography. Make sure the subject is within the auto flash shooting distance range.

The auto flash shooting distance range is 90cm to 4.5m with a negative color film.

---

**3.** Wait for the flash-ready lamp to glow; then press the shutter button. If you take the shot before the flash-ready lamp glows, exposure will be incorrect.

Do not press the shutter button halfway continuously while waiting for the ready lamp to glow. The flash will not charge.

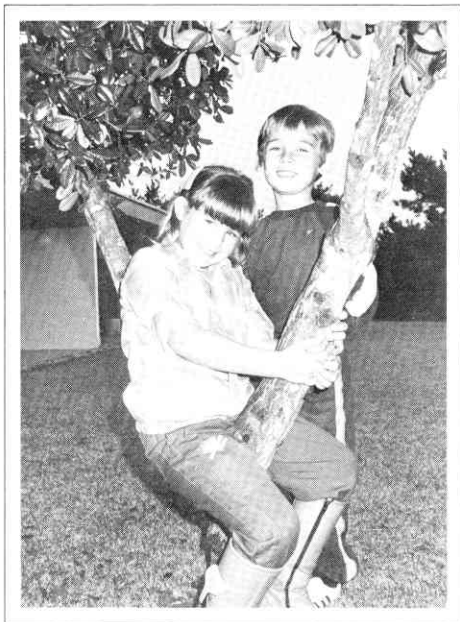

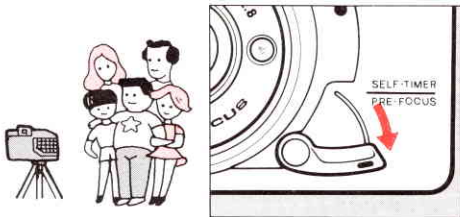

## 10 Using the Self-Timer

1. Rotate the self-timer/prefocus lever ⑧ in the direction of the arrow until it stops.
2. Look into the viewfinder and press the shutter button HALFWAY. If the red viewfinder lamp glows, pop up the flash.
3. Compose the picture so that your main subject covers the autofocus spot. If YOU will be the main subject, compose so that a substitute subject, which is at the same distance you plan to be, covers the autofocus spot.
4. Press the shutter button all the way down. Recompose the picture if necessary. The

shutter will be released automatically after a delay of about ten seconds.

If you are using the flash, do not press the shutter button until about five seconds after the flash-ready lamp glows.

### Cancellation

It is possible to cancel the self-timer before you press the shutter button simply by rotating the self-timer lever back to its original position. To cancel the self-timer after you've pressed the shutter button, follow the same procedure for prefocus cancellation. (See page 17.)

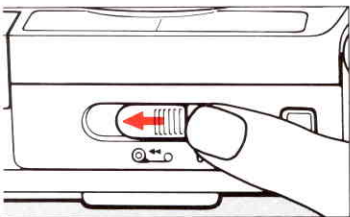

## 11 Rewinding the Film

You can tell you have come to the end of a roll of film when film advance stops automatically and when the shutter becomes impossible to release. Rewind the film IMMEDIATELY.

DO NOT open the back cover until you have rewound the film.

**1.** To rewind the film, simultaneously press the unlock button ④ and slide the film rewind switch ⑤ in the direction of the arrow until it locks into position.

Do not touch the shutter button while rewinding the film.

**2.** During rewinding, the frame counter ③ counts backwards. When it returns to "S," push the unlock button ④. The film rewind switch will then return to its original position.

**3.** Push down the back cover opening latch ⑭, open the cover, and remove the film cartridge from the film chamber. Return the film to its canister and have the film developed as soon as possible.

Be sure to shield the film from direct sources of light when unloading it.

# 12 Neckstrap and Case

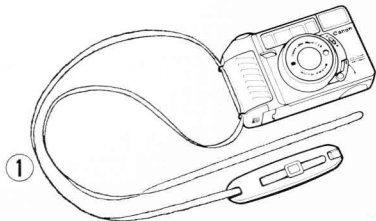

- The camera may be used with the case attached.

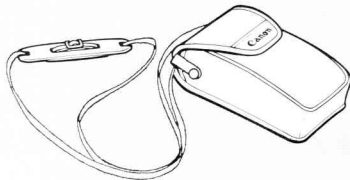

- Attach the neckstrap to the neckstrap rings, and adjust the shoulder pad until it is in the center of the strap.

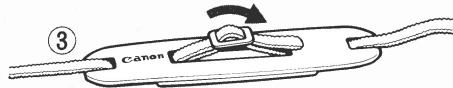
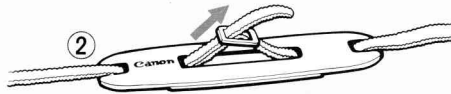

- You can also carry the camera by attaching the case to your belt.

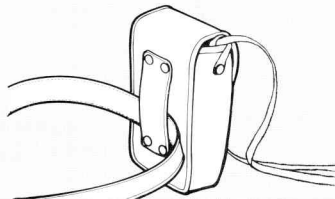

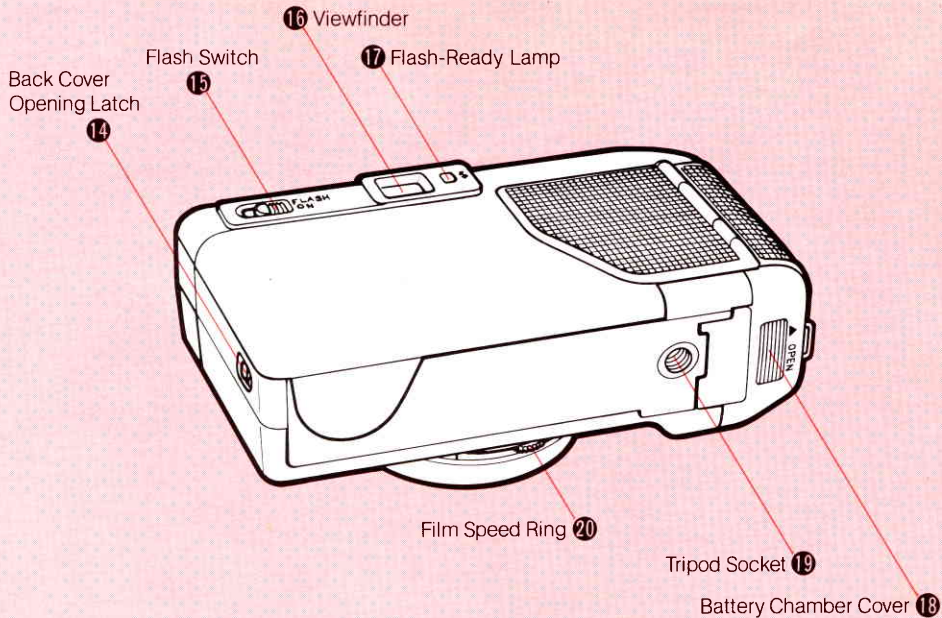

# 13 Specifications

---

**TYPE** 35mm lens-shutter camera with automatic film loading, automatic film advance, power film rewind, automatic exposure, and autofocus.

**FORMAT** 24mm × 36mm

**LENS** Canon 38mm f/2.8. Construction: 4 elements in 4 groups.

**LENS SHIELD** Open position: shooting is possible. Closed position: shooting is impossible.

**FOCUSING** Canon ACTIVE Autofocus system.

**SHOOTING DISTANCE RANGE** 0.9m (3 ft.) to infinity ( $\infty$ ).

**SHUTTER** Programmed electromagnetic shutter; also serves as diaphragm blades.

**VIEWFINDER** Bright frame finder with parallax correction frame for close focusing. Magnification: 0.45x. Information includes picture frame (1m— $\infty$ ), parallax correction frame

(0.9m—1m), autofocus spot, zone-focus symbols. Viewfinder lamp (camera shake warning/battery check LED).

**FILM LOADING** Automatic film loading by aligning leader with orange index mark in film chamber.

**BACK COVER** Opened by pressing back cover latch.

**FILM ADVANCE** Winding is automatic by pressing and releasing the shutter button for shooting.

**FILM REWINDING** Automatic upon pressing unlock button and pushing film rewind switch. Indicated by frame counter.

**FRAME COUNTER** Additive type; automatically resets to "S" by opening back cover. Counts back with film rewind.

**SELF-TIMER** Delay of about 10 seconds activated by setting self-timer lever and pressing shutter button.

---

**AUTOMATIC EXPOSURE COUPLING RANGE** EV6 (f/2.8 at 1/8 sec) to EV17 (f/16 at 1/500 sec) with ISO100/21°, ASA100 film.

**FILM SPEED SCALE** ISO50/18°, ASA50—ISO 1000/31°, ASA 1000.

**BUILT-IN FLASH** Pop-up type.

**GUIDE NUMBER** 12 (ISO100/21°, ASA100•m); 20 (ISO25/15°, ASA25•ft.)

**AUTO FLASH SHOOTING DISTANCE RANGE** 0.9—4.5m (3—15ft.) with negative color film of ISO 100/21°, ASA100 film.

**FLASH RECYCLING TIME** Less than eight seconds (interval between firing of flash and relighting of flash-ready lamp) with new alkaline batteries.

**BATTERY LIFE** Without flash, approx. 50 rolls of 36-exposure film. Using flash for each exposure, approx. 7 rolls of 36-exposure film. (Assumes use of new alkaline batteries at normal temperatures.)

**POWER SOURCE** Two size-AA alkaline (LR6) or carbon-zinc batteries. Ni-Cd batteries cannot be used.

**DIMENSIONS**

125(W) × 75.5(H) × 46(D)mm;  
(4-15/16" × 3" × 1-13/16")

**WEIGHT** 300g (10-9/16 oz.) without batteries.

Subject to change without notice.